

 S.O.ERRE



INDUSTRY
N° 3 2017



 O.ERRE

INDEX



Axial Fans

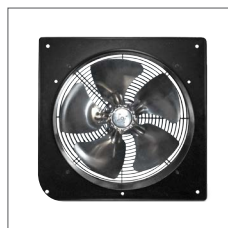

AXIA LD **12**

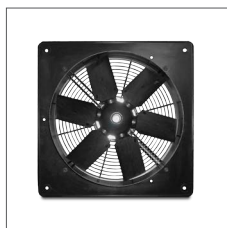

AXIA MD **14**

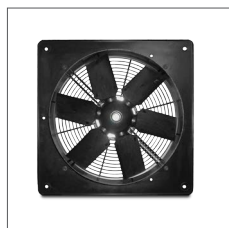

AXIA HD **16**

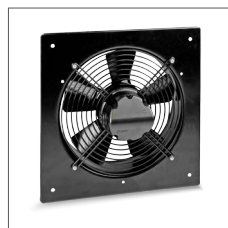

AXIA TT **18**



AXIA TT ECO **20**



AXIA AI **22**



AXIA AI ECO **25**



AXIA AI HP **27**

Destratifiers



DES **30**

Centrifugal Fans



TURBO **33**



TURBOPLAST **35**



IL R **37**



IL S **39**



IL C **41**



CB **43**



CS **45**



CAI **47**



CAA **49**



AC **51**



Box Fans



CV-D **52**



CV-2P **54**



CV-T **56**

Roof Fans



TXC **58**

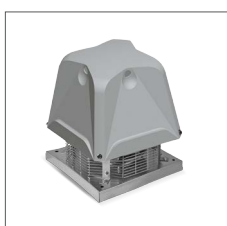

TXP **60**



TXV **62**



TXA **65**



TURBOCAMINO **67**

Antideflagranti



CB EX-ATEX **68**



CS EX-ATEX **70**



EB EX-ATEX **72**

Smoke exhaust fans for fire and car garages



PVI-HT 300°C 2h **74**



AXIA AI HT 300°C 1h **75**
AXIA AI HT 400°C 2h



CVT HT 400°C 2h **78**



TXP 400°C 2h **81**



TXV 400°C 2h **83**

Accessori industriali



ACCESSORI **85**

ALPHABETICAL INDEX

A		D	
AC	51	DES.....	30
ACCESSORIES.....	85		
AXIA AI	22	E	
AXIA AI ECO	25	EB EX ATEX	72
AXIA AI HP	27		
AXIA AI HT 300°C 1h and 400°C 2h.....	75	I	
AXIA HD.....	16	IL C	41
AXIA LD	12	IL R.....	37
AXIA MD.....	14	IL S	39
AXIA TT.....	18		
AXIA TT ECO.....	20	P	
		PVI HT 300°C 2h	74
C			
CAA	49	T	
CAI	47	TURBO	33
CB	43	TURBOCAMINO.....	67
CB EX ATEX	68	TURBOPLAST.....	35
CS.....	45	TXA	65
CS EX ATEX	70	TXC.....	58
CVT HT 400°C 2h.....	78	TXP.....	60
CV-D.....	52	TXP 400°C 2h	81
CV-T.....	56	TXV.....	62
CV-2P.....	54	TXV 400°C 2h.....	83

SYMBOLS AND ABBREVIATIONS

 = Light Duty

 = Medium Duty

 = Heavy Duty

 Energy Saving

 In case of fire

 In case of fire

 In case of fire

 Ball bearing motor for long life

 High technology engine

 Reduced dimensions

 Compass opening

 Stainless steel

 Bracket integrated

 For potential explosive atmospheres
ex-atex 94/9/EC

FEATURES

BB ball bearing motor

M single phase motor

T three phase motor

 Product with double electrical insulation

IPX4 Product protected against splash proof

APPROVALS

CE The product conforms to applicable EEC Directives

 Product approved by I.M.Q. (Italian Institute of Quality Mark)

 Explosion proof

TECHNICAL GUIDE

VENTILATING THE ROOMS

The air quality in confined spaces (indoor), can cause different unpleasant effects reactions from general malaise to more serious complications on health status. Experts have widely shown that huge concentrations of pollutants like tobacco, smoke, sweat, formaldehyde, carbon monoxide (CO₂), radon, etc... can be found in work environments, in public offices, commercial buildings.

To improve the quality of air we breath, it is necessary to ventilate the rooms where people live and carry out their several activities. Hence the need to install a fan.

HOW TO SELECT FAN

Fans are divided into three main categories, differing in power, installation and type of application.

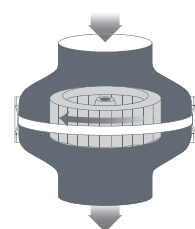
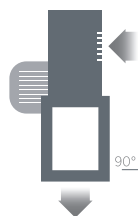
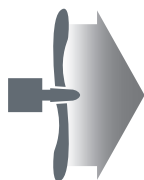

AXIAL FANS

Axial fans moving large air volumes at low pressure to extract air directly outside or through short ducts up to 1 meter maximum length.

CENTRIFUGAL FANS

Centrifugal fans moving limited air volumes at high pressure achieving a good flow against the resistance created in a duct system, with bends and elbows or wrinkled duct.

Particularly useful to ventilate areas with long ducting.

IN-LINE CENTRIFUGAL FANS

Fans equipped with centrifugal impeller to convey air in axial direction instead of radial. They have performances similar to centrifugal fans having in-line airflow.

To have a correct ventilation is essential to select the most suitable fan in accordance with the main features of the room and type of application. The table shown in the following pages states the criteria how to determine the required flow rate in any condition. In case of duct installation refer to the diagram below to calculate the pressure losses.

The recommended air changes here below have to be considered as an approximate indication only. For further information please refer to the local country rules. The following values are drawn from Prospect III contained in UNI 10339:95 standard. The values in m³/h were obtained from corresponding values in l/s (multiplying the value by 3,6) and have been rounded.

Refer to the table below for the recommended air changes per hour based upon room type.

- The calculation based on the "crowding", is carried out by multiplying the air changes per hour per person by the number of people present in the room;
- The calculation based on the "surface", is carried out by multiplying the air changes per hour by the room's surface in square meter;
- The calculation based on the "volume", is obtained by multiplying the value in the table by the volume of the room in cubic meter.

The air must be extracted from technical areas such as kitchens, bathrooms, services and therefore must be kept in vacuum.

CALCULATING AIR FLOW

TABLE FOR AIR CHANGES PER HOUR RECOMMENDED FOR A CERTAIN ENVIRONMENT TIPOLOGY

Rooms' category	Air flow rate		Ref. m ²		Ref. Volume air changes per hour
	Ref. No. People air changes per person	l/s	air changes per m ²	m ³ /h	
Residential Buildings					
houses	Bedrooms, Living rooms	11	40		4
	Kitchens, Bathrooms, Services				
	Meeting rooms	9	33		
flats	Bedrooms	11	40		
	Kitchens, Bathrooms, Services			16,5	60
	Bathrooms, Services				4
	Hall, Living rooms	11	40		
hotels	Meeting rooms	5,5	20		
	Dining rooms	10	36		
	Bedrooms	11	40		
	Bathrooms				4
	Services				8
offices	Office	11	40		
	Open space	11	40		
	Meeting rooms	10	36		
	Data processing center	7	26		
	Services				8
hospitals, clinics, nursing homes	Rooms	11	40		
	Words	11	40		
	Sterile environment	11	40		
	Medical rooms, living room	8,5	31		
	Physical therapy	11	40		
	Services				8
public buildings					
cinema theaters, conference halls	Public areas, rooms (no smoking)	5,5	20		
	Stages, TV studio	12,5	45		
	Meeting rooms (smokers)	10	36		
	Services				8
	Stock market	10	36		
	Waiting rooms				8
museums, libraries and places of worship	Exhibition halls	6	22		
	Reading rooms	5,5	20		
	Book stores			1,5	6
	Worships, churches	6	22		
	Services				8
bars, restaurants ballrooms	Bars	11	40		
	Pastry shops	6	22		
	Dining rooms	10	36		
	Ballrooms	16,5	60		
	Kitchens			16,5	
	Services				
sport buildings					
swimming pool, sauna	Swimming pool			2,5	
	Dressing room, Services				8
	Sauna			2,5	
	Sports halls	6,5	23		
	Bowling	10	36		
	Playing fields	16,5	59		
	Spectator areas	6,5	23		
	Changing rooms, Services				8
	Public services				8
school buildings	Nursery school	4	14		
	Primary school	5	18		
	Junior high school	6	22		
	Secondary school	7	25		
	University	7	25		
	Services				8
	Libraries, reading rooms	6	22		
	Music room	7	25		
	Laboratories	7	25		
	Teachers' room	6	22		
commercial buildings					
department stores	Basements	9	33		
	Upper floors	6,5	24		
shops and departments	Barbers, hairdresser	14	51		
	Clothing footwear, furniture,	11,5	42		
	Opticians, florist, photographers				
	Foodstuffs, drycleaners, pharmacies	9	33		
	Areas of public banks, pharmacies	10	36		
	Exhibition centers				

DIAGRAM FOR FAN CHOICE

LOSSES FOR BENDS AND ELBOWS

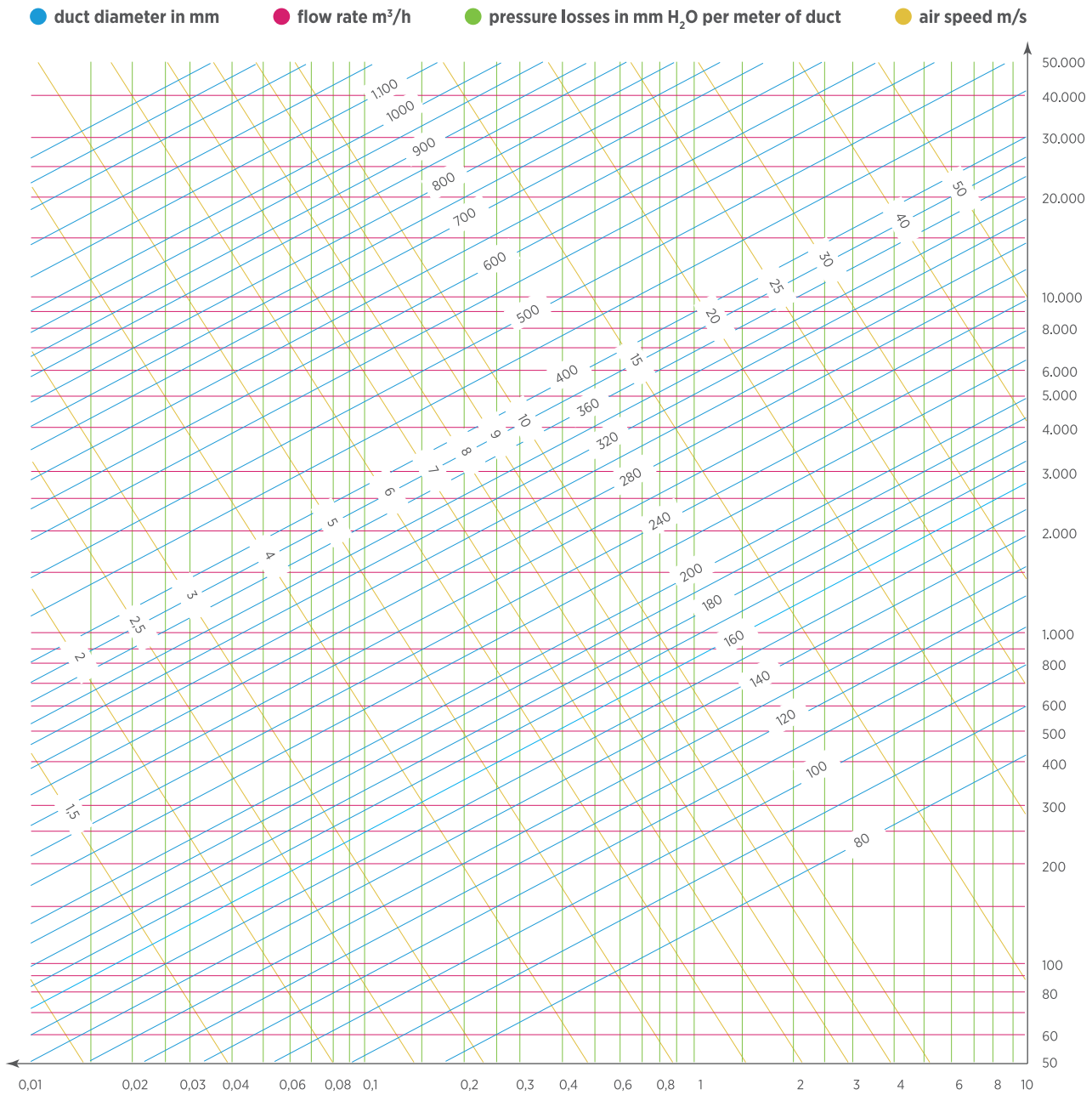

How to use the Diagram:

- 1) Start with the flow rate value (m³/h) on the right side of the diagram.
- 2) Proceed horizontally until you cross the diagonal line giving you the diameter of the duct you need.
- 3) Descend vertically to find the value of the pressure loss expressed in mm H₂O per each meter of duct. Multiply this value with the required length of pipe and you will find the total pressure loss value. If you want the value in Pa, multiply the value by 9,81.
- 4) At the intersection of the flow rate and duct diameter values, follow this line upwards until it intersects with the recommended air speed (m/sec). Once you have this value refer to Table A.

> LOSSES FOR BENDS AND ELBOWS

table A

Speed m/sec	1	2	3	4	5	6	7	8	9	10	15	20	30
Pressure loss for bend (mm H ₂ O)	0,01	0,05	0,1	0,2	0,3	0,4	0,5	0,7	0,9	1,1	2,5	4,5	10
Pressure loss for elbow (mm H ₂ O)	0,1	0,35	0,8	1,4	2	3	4	5,5	7	9	20	35	65

INDUSTRY CATALOGUE



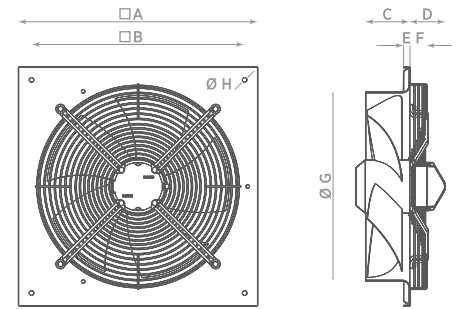

Model	A	B	C	D	E	F	Ø G	Ø H
LD 20 4	280	265	55	73	8,5	27	208	8,3
LD 25 4	340	325	66	83	8,5	27	259	8,3
LD 30 4	390	375	75	100	10	47	311	8,3
LD 35 4	460	439	85	106	12	53	363	12,3

AXIA LD - light duty

AXIAL FAN

Axial fans for light duty, wall or panel mounting to convey air directly outside or through short duct.

- Light and compact fans with reduced overall dimensions;
- Max temperature of extracted air: 40°C;
- Safety protection grille;
- Body and grille in steel protected by an epoxy-based anticorrosive paint;
- Impeller in aluminium;

- Equipped with cable connection;
- Single-phase IP42 thermally protected motor;
- Motor speed can be regulated through industrial controllers (see accessories);
- In accordance with the essential requirements of 2006/42/EC Directive concerning machines and European Standards UNI EN ISO 13857; UNI EN ISO 12499; CEI EN 60204-1.



POSITIONING

- Wall mounting

ENVIRONMENTS APPLICATION

Suitable for installation in industrial environment such as:

- Industries
- Sheds
- Warehouses
- Kitchens
- Refectories

- Sports facilities
- Supermarkets
- Shopping centers
- Cooling power plants

Also suitable for application on machines where a forced ventilation or air suction is required.

TECHNICAL DATA

Model	Code	Motor	N° poles	Rev. per minute (RPM)	Voltage (V)	Frequency (Hz)	Flow rate (m³/h)	Max press (mm H ₂ O)	Max press (Pa)	Power (W)	Nom. curr. (A)	IP motor protection	Noisiness dB(A) _{2m}	Weight (kg)
AXIA LD 20 4M	0073301	single phase	4	1400	230	50-60	550	5,1	50	30	0,2	IP42	34	2,0
AXIA LD 25 4M	0073302	single phase	4	1400	230	50-60	1100	10,2	100	55	0,4	IP42	40	3,0
AXIA LD 30 4M	0073303	single phase	4	1300	230	50-60	1400	6,6	65	70	0,5	IP42	46	4,0
AXIA LD 35 4M	0073304	single phase	4	1300	230	50-60	1700	5,6	55	72	0,5	IP42	49	5,0

FLOW CHARTS

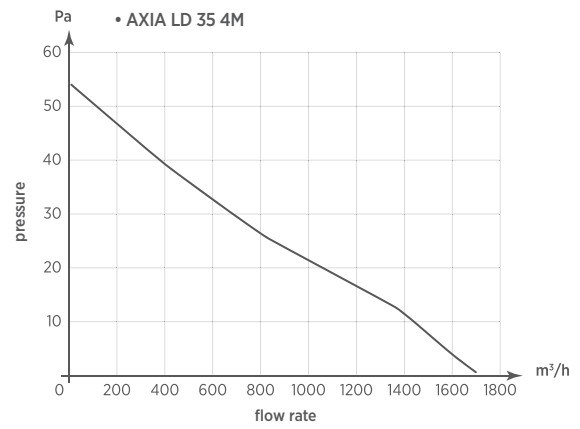
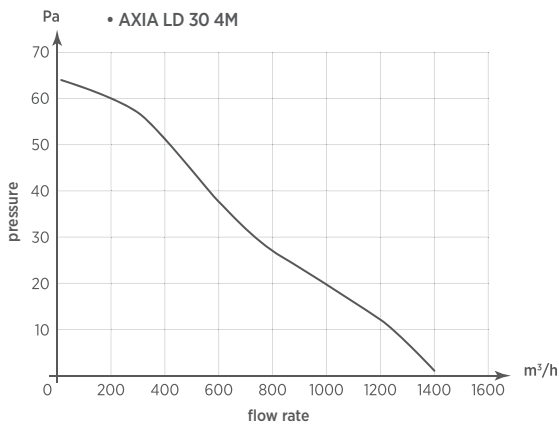
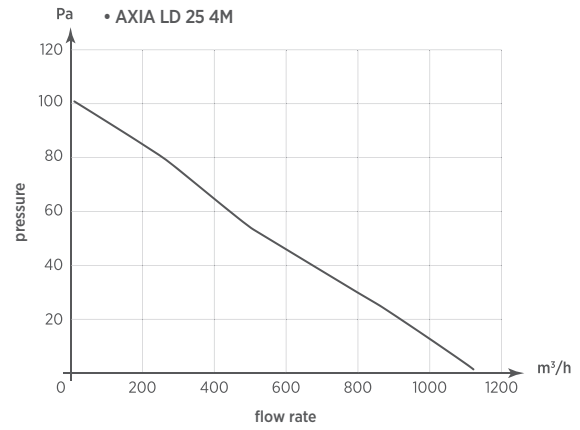
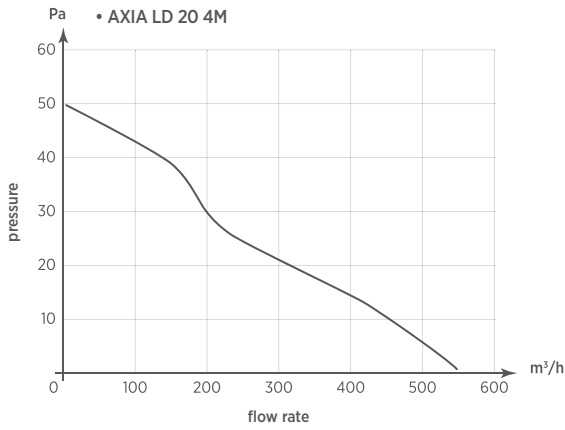

ACCESSORIES:
SEE PAGE 85



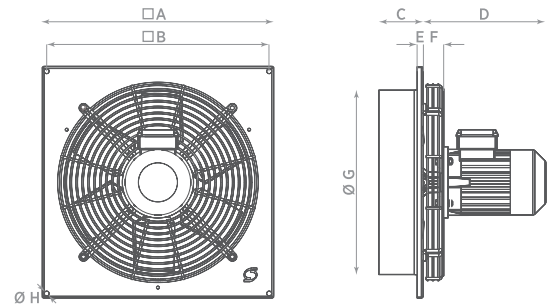

Model	A	B	C	D	E	F	Ø G	Ø H
MD 25 4	340	325	66	207	8,5	35	259	8,3
MD 30 4	390	375	75	207	10	35	311	8,3
MD 35 4	460	439	85	181	12	-	363	12,3
MD 40 4	510	490	86	181	12	-	413	12,3
MD 50 6	630	610	101	223	15	-	513	12,3
MD 50 4	630	610	101	204	15	-	513	12,3
MD 60 6	815	781	126	223	15	-	638	12,3
MD 60 4	815	781	126	224	15	-	638	12,3

AXIA MD - medium duty

AXIAL FAN

Axial fans for medium duty, wall or panel mounting to convey air directly outside or through short duct.

- Max temperature of the extracted air: 60°C;
- Safety protection grille;
- Body and grille in steel protected by an epoxy-based anticorrosive paint;
- Impeller in nylon material with high performance;
- Ball bearing class F insulation motor IP55 protected;
- Motor speed can be regulated through industrial controllers (see accessories);

- Reversibility: all models;
- Standard airflow is from motor to impeller, the opposite direction available on request;
- In accordance with the essential requirements of 2006/42/EC Directive concerning machines and European Standards UNI EN ISO 13857; UNI EN ISO 12499; CEI EN 60204-1.



POSITIONING

- Wall mounting

ENVIRONMENTS APPLICATION

Suitable for installation in industrial environment such as:

- Industries
- Sheds and Warehouses
- Greenhouses and breeding
- Parking
- Kitchens and Refectories
- Sports facilities

- Supermarkets and Shopping centers
- Cooling power plants
- Electrical generator rooms
- Electrical cabinets

Also suitable for application on machines where a forced ventilation or air suction is required.

TECHNICAL DATA

Model	Code	Motor	N° poles	Rev. per minute (RPM)	Voltage (Volt)	Frequency (Hz)	Flow rate (m³/h)	Max press. (mm H₂O)	Max press. (Pa)	Power (W)	Nom. curr. (A) 230 V	400V	IP motor protection	Noisiness dB(A) _{1m}	Weight (Kg)
AXIA MD 25 4M	0073001	Single phase	4	1400	230	50-60	1200	11,2	110	80	0,6	-	IP55	46	5,0
AXIA MD 30 4M	0073003	Single phase	4	1400	230	50-60	1800	13,8	135	100	0,7	-	IP55	50	6,1
AXIA MD 35 4M	0073005	Single phase	4	1400	230	50-60	2400	14,3	140	115	0,7	-	IP55	55	7,4
AXIA MD 40 4M	0073007	Single phase	4	1350	230	50-60	3500	17,3	170	120	0,9	-	IP55	60	8,5
AXIA MD 50 4M	0073011	Single phase	4	1400	230	50-60	6200	18,4	180	240	1,4	-	IP55	65	10,6
AXIA MD 50 6M	0073013	Single phase	6	850	230	50-60	3900	6,6	65	110	0,4	-	IP55	55	10,8
AXIA MD 60 4M	0073015	Single phase	4	1350	230	50-60	9000	19,4	190	270	1,7	-	IP55	70	14,5
AXIA MD 60 6M	0073017	Single phase	6	750	230	50-60	5200	6,1	60	120	0,45	-	IP55	56	14,7
AXIA MD 25 4T	0073002	Threee phase	4	1400	230/400	50-60	1200	11,2	110	80	0,6	0,3	IP55	46	5,0
AXIA MD 30 4T	0073004	Threee phase	4	1400	230/400	50-60	1800	13,8	135	100	0,7	0,4	IP55	50	6,1
AXIA MD 35 4T	0073006	Threee phase	4	1400	230/400	50-60	2400	14,3	140	115	0,7	0,4	IP55	55	7,4
AXIA MD 40 4T	0073008	Threee phase	4	1350	230/400	50-60	3500	17,3	170	120	0,8	0,5	IP55	60	8,5
AXIA MD 50 4T	0073012	Threee phase	4	1400	230/400	50-60	6200	18,4	180	240	1,3	0,8	IP55	65	10,6
AXIA MD 50 6T	0073014	Threee phase	6	850	230/400	50-60	3900	6,6	65	110	0,37	0,21	IP55	55	10,8
AXIA MD 60 4T	0073016	Threee phase	4	1350	230/400	50-60	9000	19,4	190	270	1,4	0,8	IP55	70	14,5
AXIA MD 60 6T	0073018	Threee phase	6	750	230/400	50-60	5200	6,1	60	120	0,43	0,25	IP55	56	14,7

FLOW CHARTS

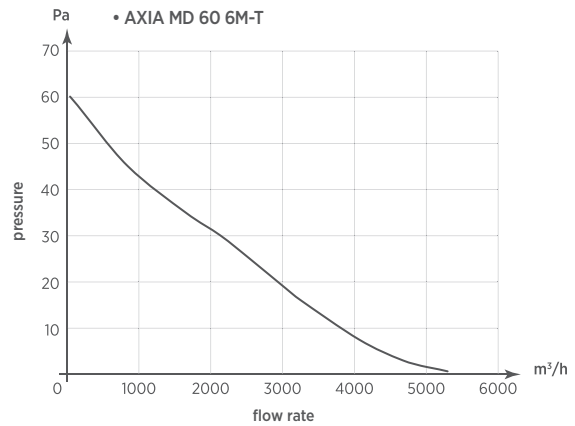
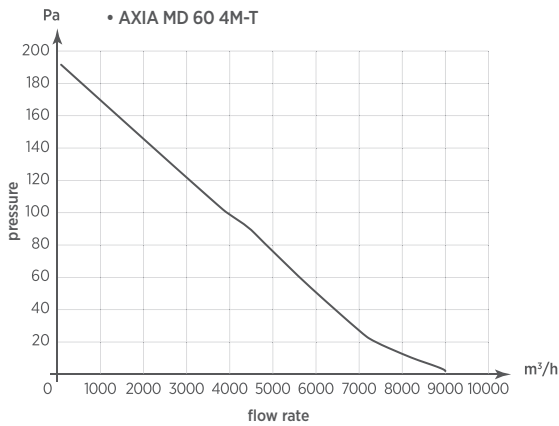
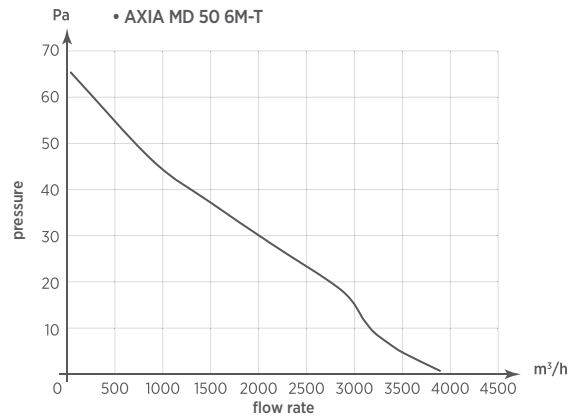
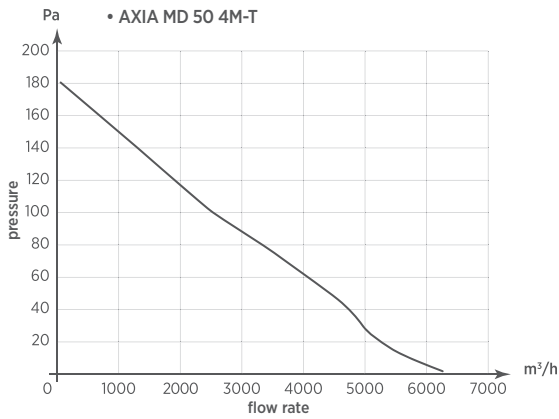
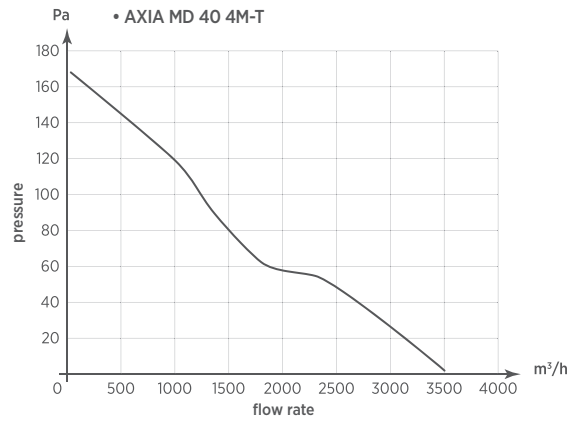
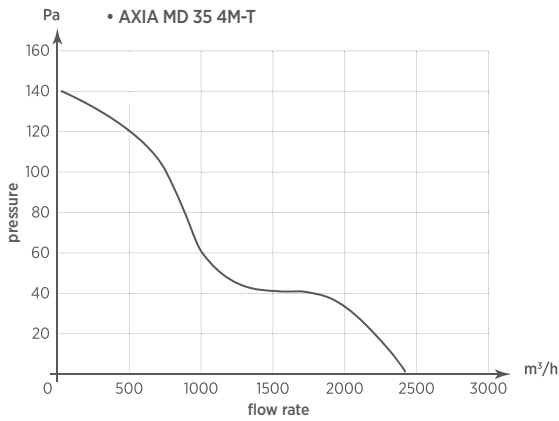
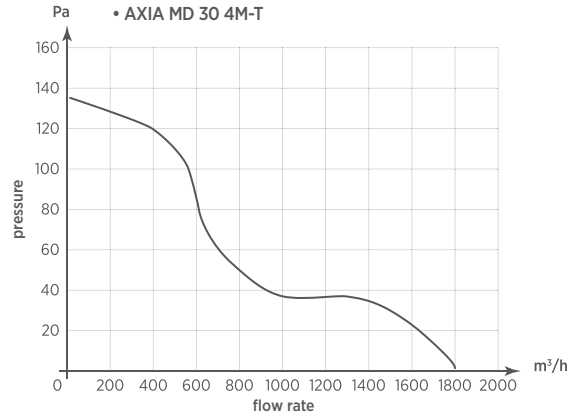
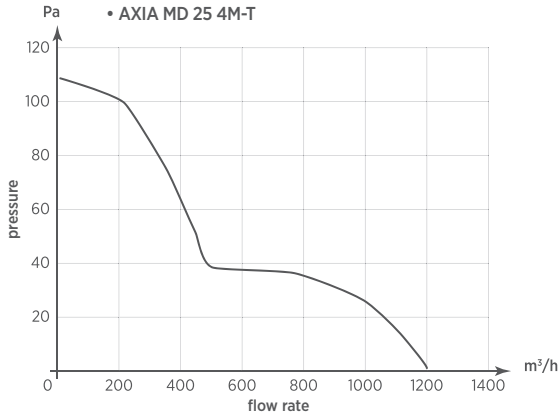

ACCESSORIES:
SEE PAGE 85

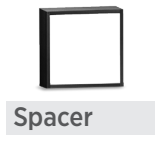

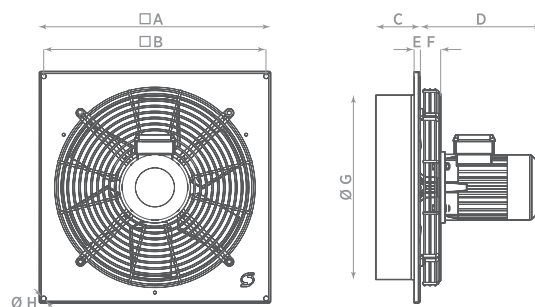

Model	A	B	C	D	E	F	Ø G	Ø H
HD 25 4	340	325	66	207	8,5	35	259	8,3
HD 30 4	390	375	75	207	10	35	311	8,3
HD 35 4	460	439	85	181	12	-	363	12,3
HD 40 4	510	490	86	204	12	-	413	12,3
HD 50 6	630	610	101	223	15	-	513	12,3
HD 50 4	630	610	101	204	15	-	513	12,3
HD 60 4	815	781	126	224	15	-	638	12,3

AXIA HD - heavy duty

AXIAL FAN

Axial fans for heavy duty, with high airflow capacity, wall or panel mounting to convey air directly outside or through short duct.

- Max temperature of extracted air: 60°C;
- Safety protection grille;
- Body and grille in steel protected by an epoxy-based anticorrosive paint;
- Impeller in nylon material with high performance;
- Ball bearing class F insulation motor IP55 protected;
- Motor speed can be regulated through industrial controllers (see

accessories);

- Reversibility: all models;
- Standard airflow is from motor to impeller, the opposite direction available on request;
- In accordance with the essential requirements of 2006/42/EC Directive concerning machines and European Standards UNI EN ISO 13857; UNI EN ISO 12499; CEI EN 60204-1.

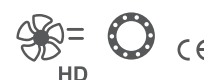

POSITIONING

- Wall mounting

ENVIRONMENTS APPLICATION

Suitable for installation in industrial environment such as:

- Industries
- Sheds and Warehouses
- Greenhouses and breeding
- Parking
- Kitchens and Refectories
- Sports facilities

- Supermarkets and Shopping centers
- Cooling power plants
- Electrical generator rooms
- Electrical cabinets

Also suitable for application on machines where a forced ventilation or air suction is required.

(*) Models not in compliance with Reg.327/11, only for extra UE market.

TECHNICAL DATA

Model	Code	Motor	N° poles	Rev. per minute (RPM)	Voltage (Volt)	Frequency (Hz)	Flow rate (m³/h)	Max press. (mm H ₂ O)	Max press. (Pa)	Power (W)	Nom. curr. (A) 230 V	400 V	IP Motor protection	Noisiness dB(A) _{2m}	Weight (Kg)
AXIA HD 25 4M	0073101	Single phase	4	1400	230	50-60	1450	12,2	120	90	0,6	-	IP55	47	5,0
AXIA HD 30 4M	0073103	Single phase	4	1400	230	50-60	2150	14,8	145	120	0,7	-	IP55	52	6,1
AXIA HD 35 4M	0073105	Single phase	4	1350	230	50-60	2900	15,8	155	150	0,9	-	IP55	57	7,4
AXIA HD 40 4M	0073107	Single phase	4	1400	230	50-60	4400	19,4	190	280	1,4	-	IP55	61	9,5
AXIA HD 50 4M	0073111	Single phase	4	1300	230	50-60	7500	19,9	195	420	1,9	-	IP55	68	10,6
AXIA HD 50 6M	0073113	Single phase	6	950	230	50-60	5200	6,1	85	220	1,2	-	IP55	60	10,8
AXIA HD 60 4M	0073115	Single phase	4	1400	230	50-60	12000	20,4	200	650	3	-	IP55	74	16,4
AXIA HD 25 4T	0073102	Threese phase	4	1400	230/400	50-60	1450	12,2	120	90	0,7	0,3	IP55	47	5,0
AXIA HD 30 4T	0073104	Threese phase	4	1400	230/400	50-60	2150	14,8	145	120	0,7	0,4	IP55	52	6,1
AXIA HD 35 4T	0073106	Threese phase	4	1350	230/400	50-60	2900	15,8	155	150	0,8	0,5	IP55	57	7,4
AXIA HD 40 4T	0073108	Threese phase	4	1400	230/400	50-60	4400	19,4	190	280	1,3	0,7	IP55	61	9,5
AXIA HD 50 4T	0073112	Threese phase	4	1300	230/400	50-60	7500	19,9	195	420	1,6	0,9	IP55	68	10,6
AXIA HD 50 6T	0073114	Threese phase	6	950	230/400	50-60	5200	6,1	85	220	1,2	0,7	IP55	60	10,8
AXIA HD 60 4T	0073116	Threese phase	4	1400	230/400	50-60	12000	20,4	200	650	2,2	1,3	IP55	74	16,4

FLOW CHARTS

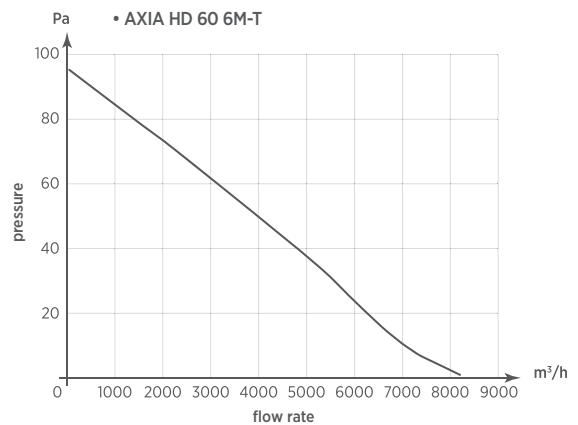
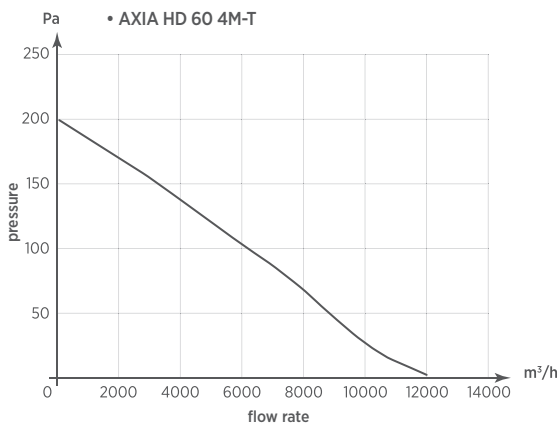
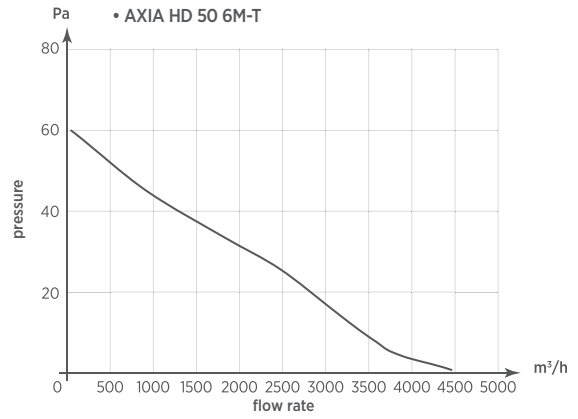
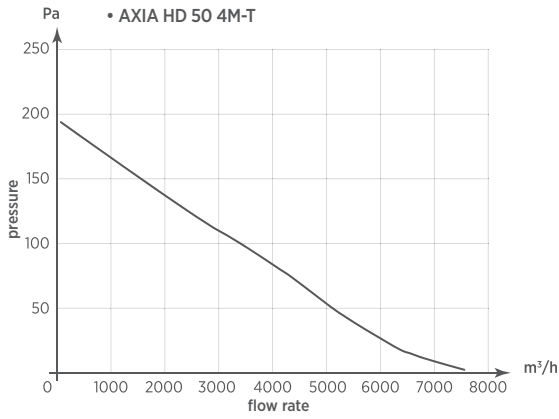
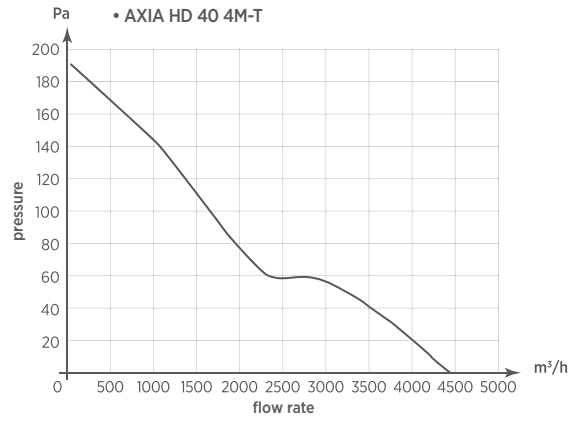
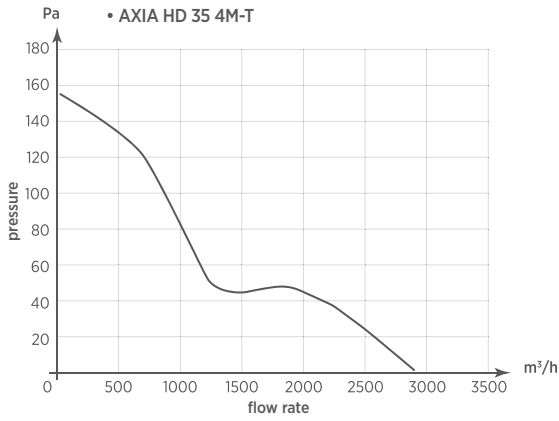
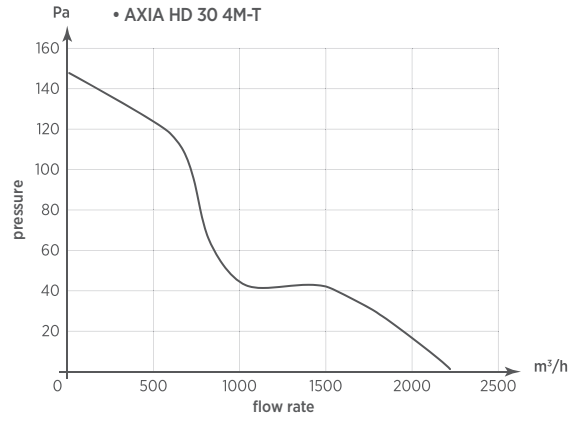
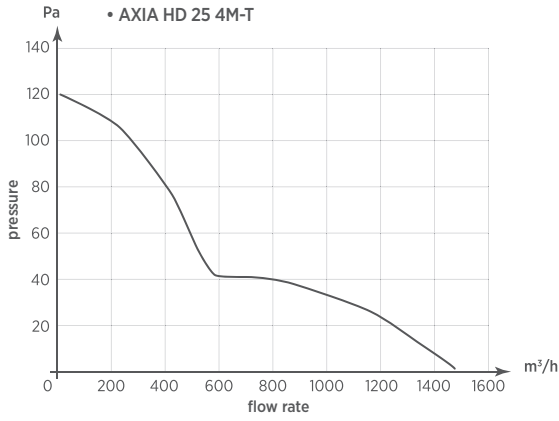

ACCESSORIES:
SEE PAGE 85

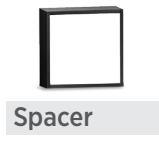

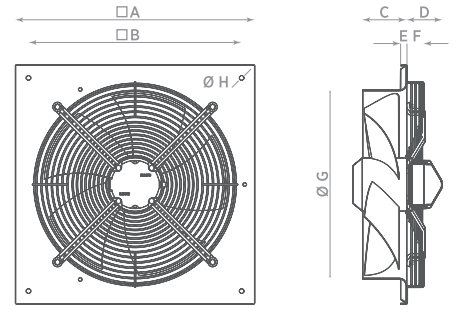

Model	A	B	C	D	E	F	Ø G	Ø H
TT 20 2/4	280	265	55	64	8,5	-	208	8,3
TT 25 4	340	325	66	64	8,5	-	259	8,3
TT 30 4	390	375	75	93	10	57,5	311	8,3
TT 35 4	460	439	85	67	12	35	363	12,3
TT 40 4	510	490	86	67	12	35	413	12,3
TT 50 4	630	610	101	96	15	77	513	12,3
TT 60 4	815	781	126	83	15	65	638	12,3

AXIA TT - techno type

AXIAL FAN

Axial fans high performances with high tech motor, wall or panel mounting to convey air or fumes directly outside or through short duct.

- Compact fans with reduced overall dimensions;
- Max temperature of extracted air: 55°C;
- Low sound level compared with high performance;
- Safety protection grille;
- Body and impeller in steel protected by an epoxy-based anticorrosive paint;
- Motor impeller with external rotor, statically and dynamically balanced;

- Ball bearing class F insulation motor, IP44 or IP54 protected (depending on the model);
- Motor speed can be regulated through industrial controllers (see accessories);
- Reversibility, all models except 20 4M and 25 4M;
- In accordance with the essential requirements of 2006/42/EC Directive concerning machines and European Standards UNI EN ISO 13857; UNI EN ISO 12499; CEI EN 60204-1.



POSITIONING

- Wall mounting

ENVIRONMENTS APPLICATION

Suitable for installation in industrial environment such as:

- Industries
- Sheds and Warehouses
- Greenhouses and breeding
- Parking
- Kitchens and Refectories

- Sports facilities
- Supermarkets and Shopping centers
- Cooling power plants
- Electrical generator rooms

Also suitable for application on machines where a forced ventilation or air suction is required.

TECHNICAL DATA

Model	Code	Motor	N° poles	Rev. per minute (RPM)	Voltage (Volt)	Frequency (Hz)	Flow rate (m³/h)	Max press (mm H ₂ O)	Max press (Pa)	Power (W)	Nom. curr. (A) 230 V	400 V	IP Motor protection	Noisiness dB(A) _{1m}	Weight (Kg)
AXIA TT 20 2M	0073201	single phase	2	2650	230	50-60	900	16,4	160	65	0,3	-	IP44	59	2
AXIA TT 20 4M	0073202	single phase	4	1400	230	50-60	500	8,2	80	40	0,3	-	IP44	45	2
AXIA TT 25 4M	0073204	single phase	4	1400	230	50-60	1000	10,2	100	70	0,5	-	IP44	52	3
AXIA TT 30 4M	0073206	single phase	4	1400	230	50-60	1900	12,8	125	65	0,4	-	IP44	59	4
AXIA TT 35 4M	0073208	single phase	4	1400	230	50-60	3400	13,3	130	130	0,7	-	IP44	63	5
AXIA TT 40 4M	0073210	single phase	4	1400	230	50-60	4400	16,4	160	180	0,8	-	IP44	63	8
AXIA TT 20 4T	0073203	three phase	4	1400	230/400	50-60	500	8,2	80	20	0,2	0,1	IP44	45	2
AXIA TT 25 4T	0073205	three phase	4	1400	230/400	50-60	1000	10,2	100	25	0,2	0,1	IP44	52	3
AXIA TT 30 4T	0073207	three phase	4	1400	230/400	50-60	1900	12,8	125	55	0,3	0,2	IP44	59	4
AXIA TT 35 4T	0073209	three phase	4	1400	230/400	50-60	3400	13,3	130	130	0,7	0,4	IP44	63	5
AXIA TT 40 4T	0073211	three phase	4	1400	230/400	50-60	4400	16,4	160	195	0,8	0,5	IP44	63	8
AXIA TT 50 4T	0073212	three phase	4	1400	230/400	50-60	9000	17,3	170	530	2,3	1,3	IP54	74	17
AXIA TT 60 6T	0073213	three phase	6	950	230/400	11200	80,0	8,2	80	510	2,3	1,3	IP54	65	22

FLOW CHARTS

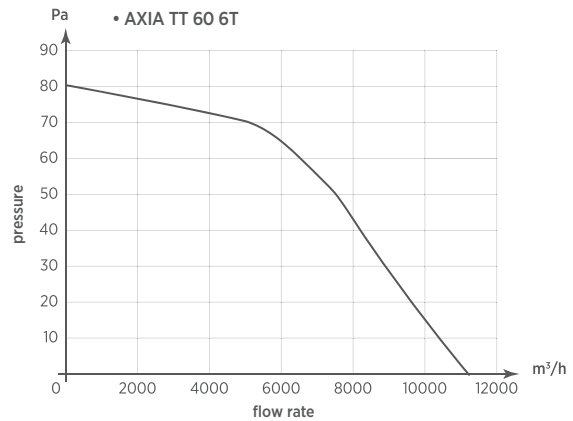
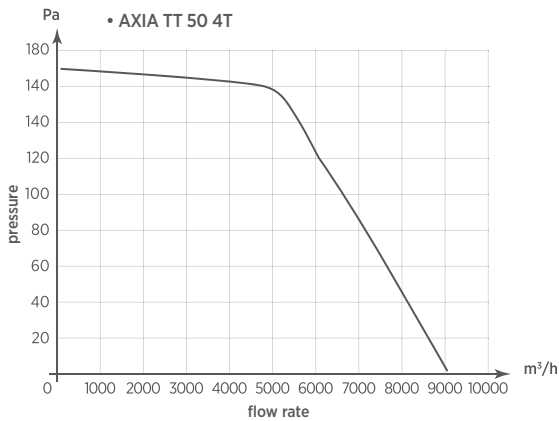
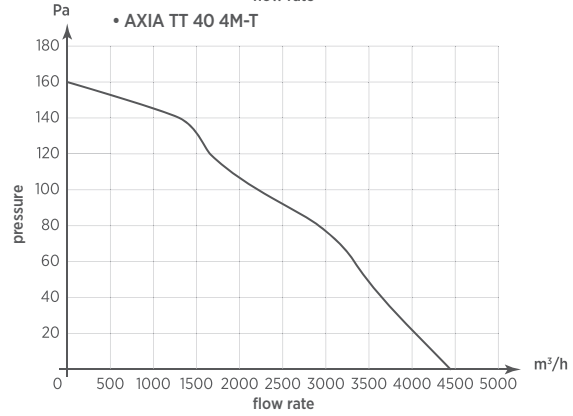
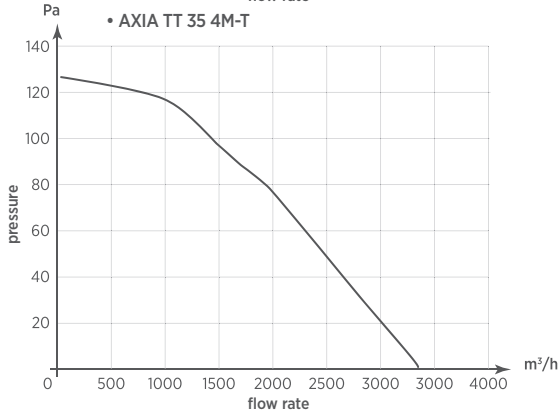
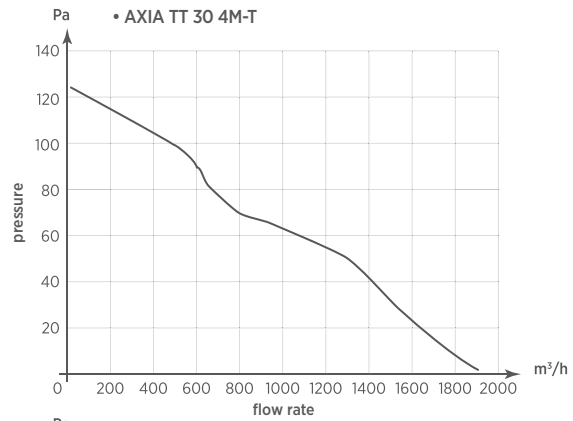
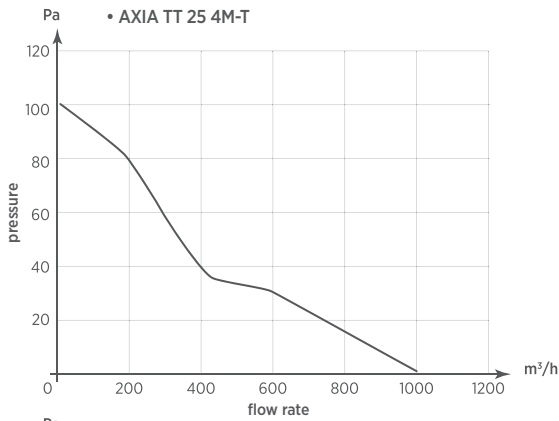
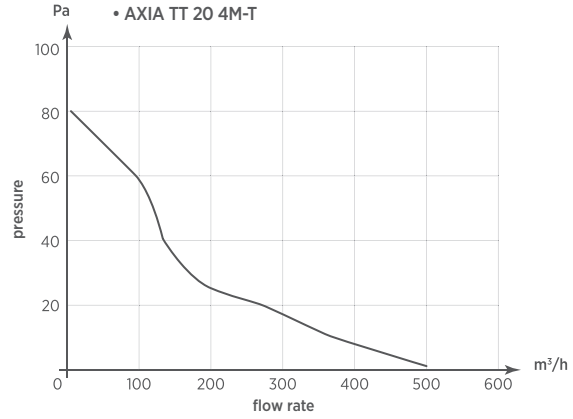
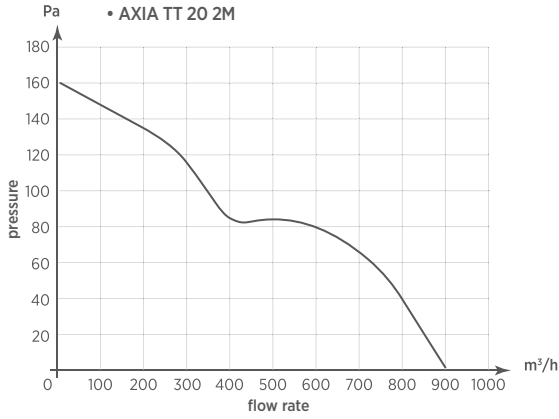

ACCESSORIES:
SEE PAGE 85



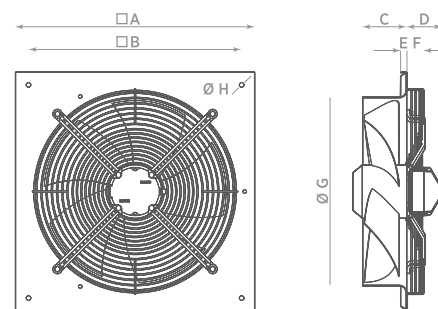

Model	A	B	C	D	E	F	ØG	ØH
TT ECO 25	340	325	66	64	8	4	259	8,3
TT ECO 30	390	375	75	97	10	57	311	8,3
TT ECO 35	460	439	91	100	12	40	363	12,3
TT ECO 40	510	490	85	99	12	66	413	12,3
TT ECO 50	630	610	101	152	15	93	513	12,3
TT ECO 60	851	781	125	98	15	40	640	12,3

AXIA TT ECO - techno type

AXIAL FAN

Axial fans high performances with high tech EC motor, wall or panel mounting to convey air or fumes directly outside or through short duct.

- Compact fans with reduced overall dimensions;
- Max temperature of extracted air: 60°C;
- Low sound level compared with high performance;
- Safety protection grille;
- Body in steel protected by an epoxy-based anticorrosive paint;
- Motor impeller with external rotor, statically and dynamically balanced,

impeller in plastic PP material;

- Ball bearing class B insulation motor, IP54 protected;
- Motor speed can be regulated through RGM 10 controller, included (or through RG 10 controller, available as accessory);
- In accordance with the essential requirements of 2006/42/EC Directive concerning machines and European Standards UNI EN ISO 13857; UNI EN ISO 12499; CEI EN 60204-1.



POSITIONING

- Wall mounting

ENVIRONMENTS APPLICATION

Suitable for installation in industrial environment such as:

- Industries
- Sheds and Warehouses
- Greenhouses and breeding
- Parking
- Kitchens and Refectories
- Sports facilities

- Supermarkets and Shopping centers
- Cooling power plants
- Electrical generator rooms
- Electrical cabinets

Also suitable for application on machines where a forced ventilation or air suction is required.

TECHNICAL DATA

Model	Code	Motor	Rev. per minute (RPM)	Voltage (Volt)	Frequency (Hz)	Flow rate (m ³ /h)	Max press (mm H ₂ O)	Max press (Pa)	Power (W)	Nom. curr. (A) 230 V	IP Motor protection	Noisiness dB(A) _{2m}	Weight (kg)
AXIA TT ECO 25 M	0073214	Single phase	2400	230	50-60	1500	22,4	220	50	0,45	IP54	47	3
AXIA TT ECO 30 M	0073215	Single phase	1600	230	50-60	2200	9,2	90	65	0,5	IP54	46	3,9
AXIA TT ECO 35 M	0073216	Single phase	1200	230	50-60	2900	7,1	70	75	0,6	IP54	48	5,5
AXIA TT ECO 40 M	0073217	Single phase	1100	230	50-60	4100	8,2	80	80	0,5	IP54	51	6,5
AXIA TT ECO 50 M	0073218	Single phase	1100	230	50-60	7100	11,2	110	280	1,8	IP54	52	11,5
AXIA TT ECO 60 M	0073219	Single phase	800	230	50-60	8900	8,7	85	240	1,1	IP54	47	15,5

FLOW CHARTS

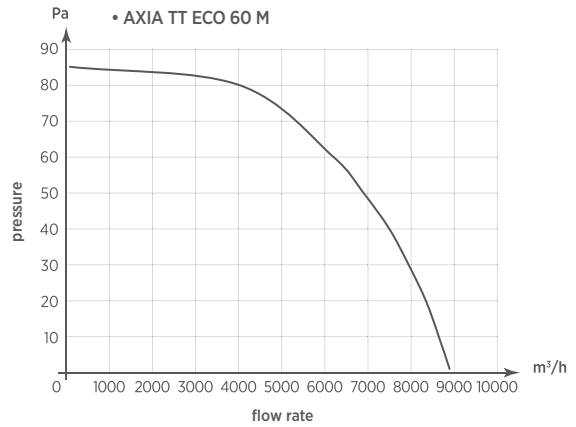
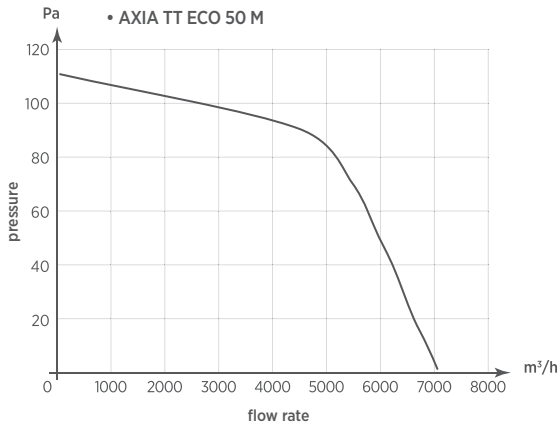
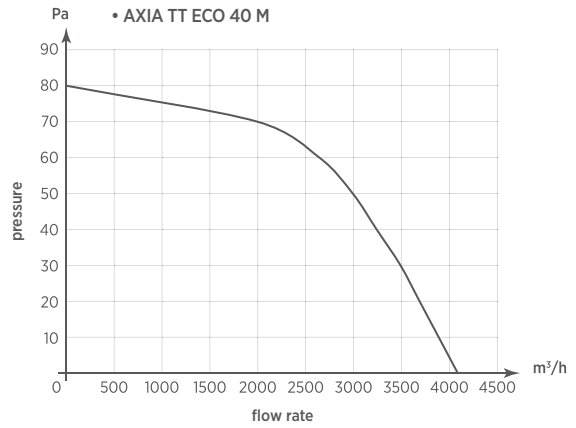
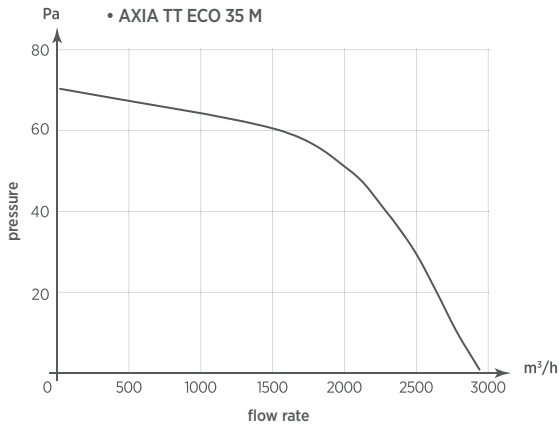
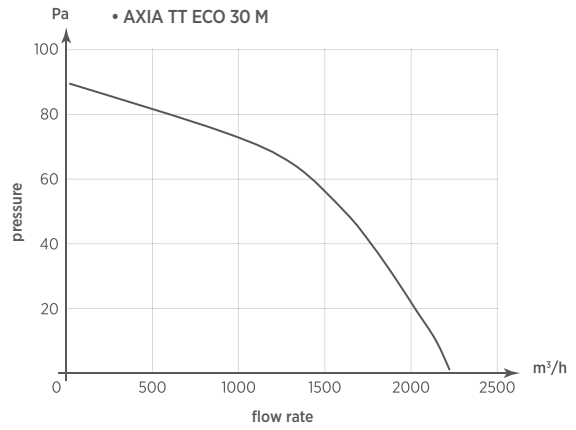
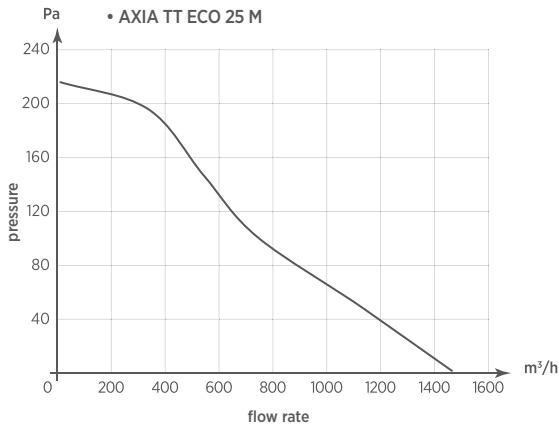

ACCESSORIES:
SEE PAGE 85



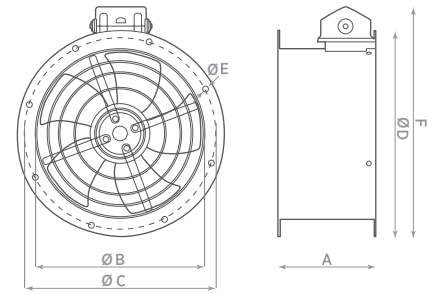

Model	A	Ø B	Ø C	Ø D	Ø E	F	Holes
AXIA AI 25	160	258	280	308	10	352	4×90°
AXIA AI 30	180	310	355	382	10	425	8×45°
AXIA AI 35	180	360	395	422	10	471	8×45°
AXIA AI 40	190	408	450	480	12	524	8×45°
AXIA AI 45	220	452	500	530	12	572	8×45°
AXIA AI 50	220	505	560	590	12	628	12×30°
AXIA AI 60	220	636	690	720	12	760	12×30°

AXIA AI

AXIAL DUCT FAN

Axial duct fans to convey air outside or fumes coming from ducts.

- Double ring flange;
- Compact fans with reduced overall dimensions;
- Low sound level compared with high performance;
- Max temperature of extracted air: 60°C;
- Body in steel protected by an epoxy-based anticorrosive paint;
- Impeller in steel protected by an epoxy-based anticorrosive paint or in plastic PP material;
- Motor impeller with external rotor mounted on ball bearing, insulation Class

B or F;

- Reversibility: Three-phase: all models; Single-phase: all models except AXIA AI 25 4M;
- Flange in accordance with ISO 13351;
- Motor speed can be regulated through industrial controllers (see accessories);
- In accordance with the essential requirements of 2006/42/EC Directive concerning machines and European Standards UNI EN ISO 13857; UNI EN ISO 12499; CEI EN 60204-1.



POSITIONING

- Duct mounting

ENVIRONMENTS APPLICATION

Suitable for installation in industrial environment such as:

- Industries
- Sheds and Warehouses
- Greenhouses and breeding
- Parking
- Kitchens and Refectories

- Sports facilities
- Supermarkets and Shopping centers
- Cooling power plants
- Electrical generator rooms
- Electrical cabinets

TECHNICAL DATA

Model	Code	Motor	Rev. per min. (RPM)	Voltage (Volt)	Frequency (Hz)	Flow rate (m³/h)	Max press (mm H ₂ O)	Max press (Pa)	Power (W)	Nom. Curr. (A)		IP Motor protection	Noisiness dB(A) _{1m}	Weight (kg)
										230 V	400 V			
AXIA AI 25 2M	0073400	single phase	2500	230	50-60	1650	29,6	290	110	0,5	-	IP44	66	4,5
AXIA AI 25 4M	0073405	single phase	1400	230	50-60	1000	10,2	100	70	0,5	-	IP44	52	4
AXIA AI 30 2M	0073410	single phase	2650	230	50-60	3300	28,6	280	230	1,1	-	IP44	70	7
AXIA AI 30 4M	0073415	single phase	1350	230	50-60	1800	12,8	125	70	0,3	-	IP44	49	6
AXIA AI 35 4M	0073420	single phase	1350	230	50-60	3300	16,3	160	165	0,7	-	IP44	55	7
AXIA AI 40 4M	0073430	single phase	1400	230	50-60	4250	20,4	200	170	0,8	-	IP44	62	10
AXIA AI 45 4M	0073440	single phase	1300	230	50-60	7000	20,4	200	400	2,4	-	IP54	57	12
AXIA AI 25 2T	0073401	three phase	2500	400	50-60	1650	29,6	290	110	0,35	0,2	IP44	66	4
AXIA AI 25 4T	0073406	three phase	1400	400	50-60	1000	10,2	100	25	0,2	0,1	IP44	52	4
AXIA AI 30 2T	0073411	three phase	2600	400	50-60	3300	28,6	280	200	1	0,6	IP44	70	7
AXIA AI 30 4T	0073416	three phase	1350	400	50-60	1800	12,8	125	65	-	0,14	IP44	46	6
AXIA AI 35 4T	0073421	three phase	1400	400	50-60	3300	16,3	160	170	0,7	0,4	IP44	55	7
AXIA AI 40 4T	0073431	three phase	1400	400	50-60	4200	20,4	200	140	0,8	0,5	IP44	62	10
AXIA AI 45 4T	0073441	three phase	1300	400	50-60	7000	20,4	200	450	-	1	IP54	58	12
AXIA AI 50 4T	0073450	three phase	1400	400	50-60	9000	23,5	230	550	2,2	1,2	IP54	62	20
AXIA AI 60 6T	0073455	three phase	900	400	50-60	11300	15,3	150	450	1,9	1,1	IP54	58	25

FLOW CHARTS

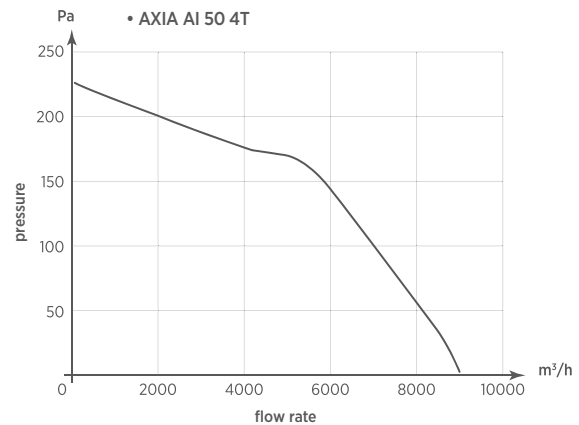
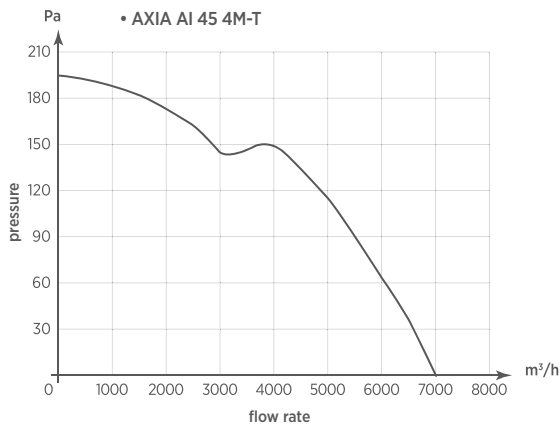
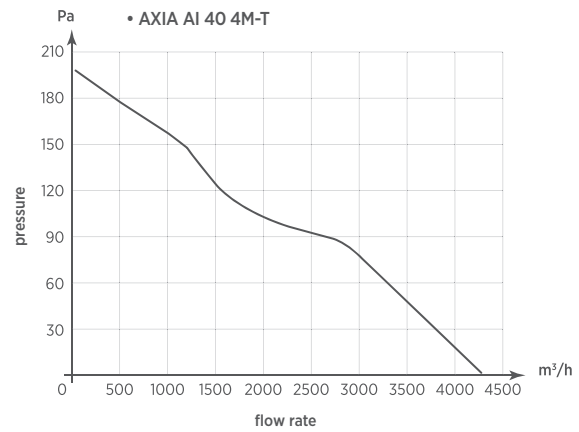
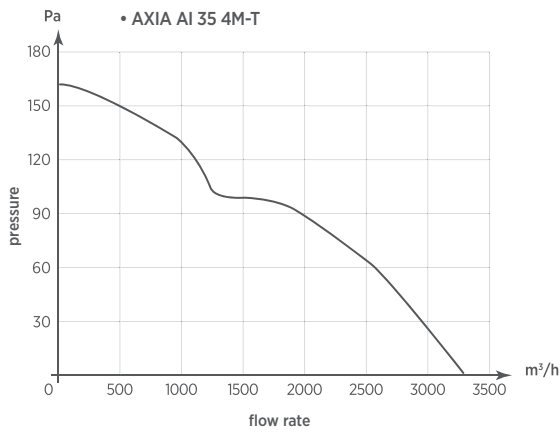
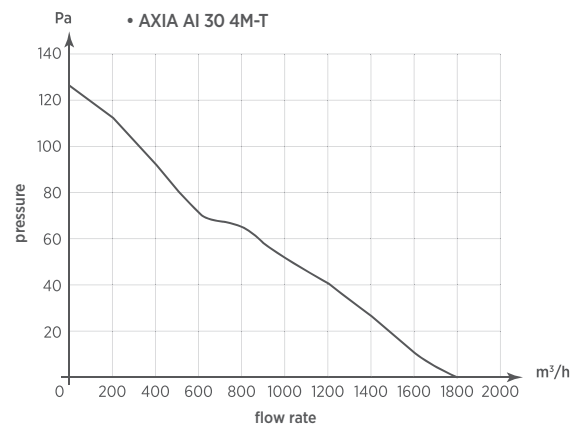
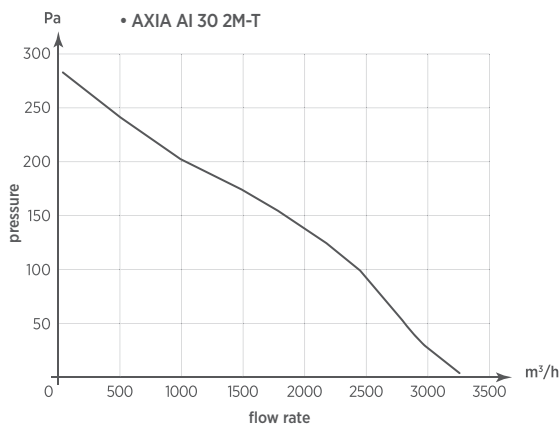
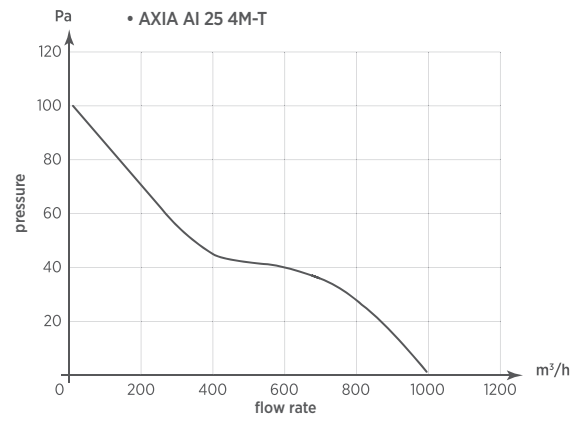
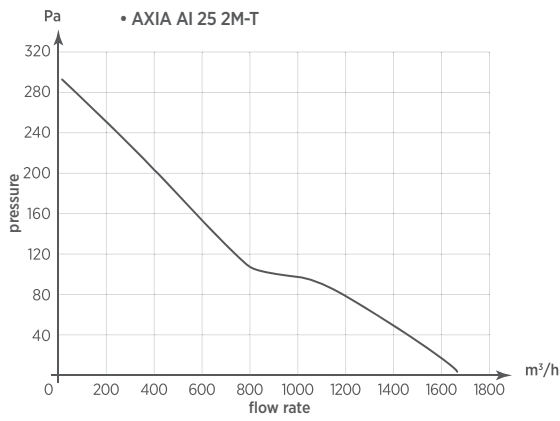

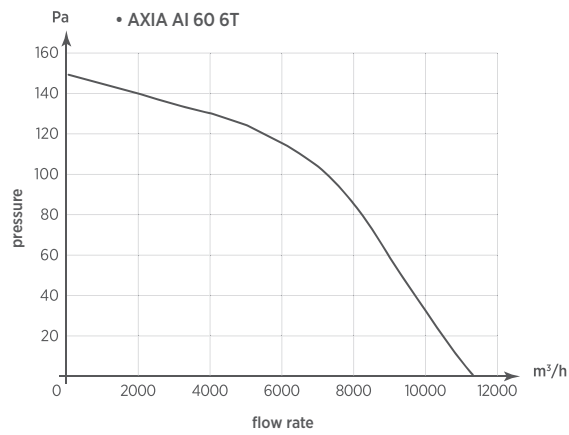
**ACCESSORIES:**

SEE PAGE 85



Controllers



Safety protection grille



Connection flange



Extension ring

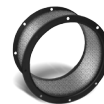

Flexible connection



Support

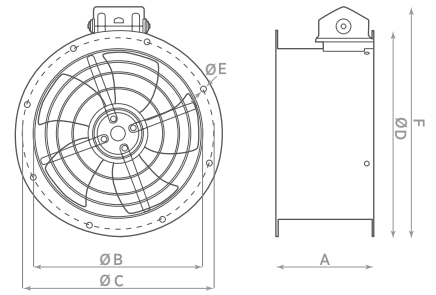

Model	A	ØB	ØC	ØD	ØE	F	Holes
AXIA AI ECO 25	160	258	280	308	10	362	4 x 90°
AXIA AI ECO 30	180	310	355	382	10	425	8 x 45°
AXIA AI ECO 35	180	360	395	422	10	471	8 x 45°
AXIA AI ECO 40	190	408	450	480	12	524	8 x 45°
AXIA AI ECO 45	220	452	500	530	12	572	8 x 45°
AXIA AI ECO 50	220	505	560	590	12	628	12 x 30°
AXIA AI ECO 60	220	636	690	720	12	760	12 x 30°

AXIA AI ECO

AXIAL FAN

Axial duct fans, high performances with EC brushless motor to convey air outside or fumes coming from ducts.

- Double ring flange;
- Compact fans with reduced overall dimensions;
- Low sound level compared with high performance;
- Max temperature of extracted air: 60°C;
- Body and grille in steel protected by an epoxy-based anticorrosive paint;
- Motor impeller with external rotor mounted on ball bearing, insulation Class

- B and IP54 protected;
- Impeller in plastic material, statically and dynamically balanced;
- Flange in accordance with ISO 13351;
- Motor speed can be regulated through RGM 10 controller, included (or through RG 10 controller, available as accessory);
- In accordance with the essential requirements of 2006/42/EC Directive concerning machines and European Standards UNI EN ISO 13857; UNI EN ISO 12499; CEI EN 60204-1.



POSITIONING

- Duct mounting

ENVIRONMENTS APPLICATION

Suitable for installation in industrial environment such as:

- Industries
- Sheds and Warehouses
- Greenhouses and breeding
- Parking
- Kitchens and Refectories
- Sports facilities
- Supermarkets and Shopping centers
- Cooling power plants
- Electrical generator rooms
- Electrical cabinets

TECHNICAL DATA

Model	Code	Motor	Rev. per min. (RPM)	Voltage (Volt)	Frequency (Hz)	Flow rate (m ³ /h)	Max press (mm H ₂ O)	Max press (Pa)	Power (W)	Nom. curr. (A) 230 V	Noisiness dB(A) _{1m}	Weight (kg)
AXIA AI ECO 25 M	0073460	single phase	2400	230	50-60	1600	22,4	220	50	0,45	51	4,0
AXIA AI ECO 30 M	0073462	single phase	1500	230	50-60	2200	15,3	150	70	0,5	49	4,5
AXIA AI ECO 35 M	0073464	single phase	1250	230	50-60	3000	10,2	100	75	0,6	51	7,0
AXIA AI ECO 40 M	0073466	single phase	1100	230	50-60	4100	14,3	140	140	1,1	56	8,0
AXIA AI ECO 45 M	0073468	single phase	1300	230	50-60	6500	28,6	280	350	2,2	59	10,0
AXIA AI ECO 50 M	0073470	single phase	1100	230	50-60	7350	16,3	160	360	2,2	54	13,0
AXIA AI ECO 60 M	0073472	single phase	800	230	50-60	9000	13,3	130	240	1,0	50	16,0

FLOW CHARTS

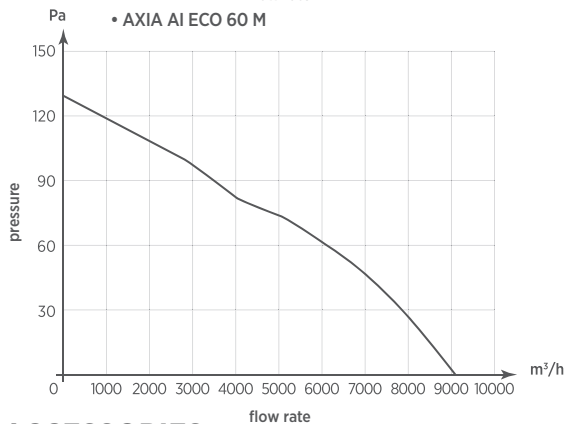
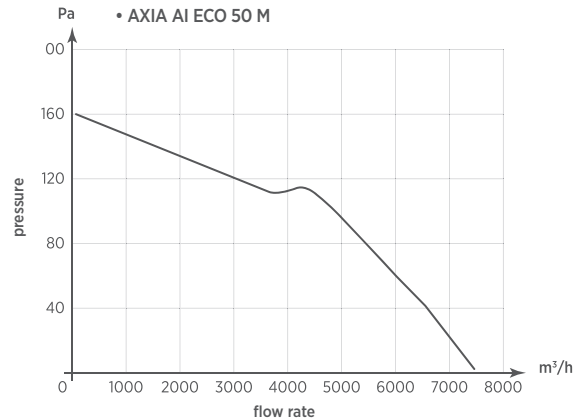
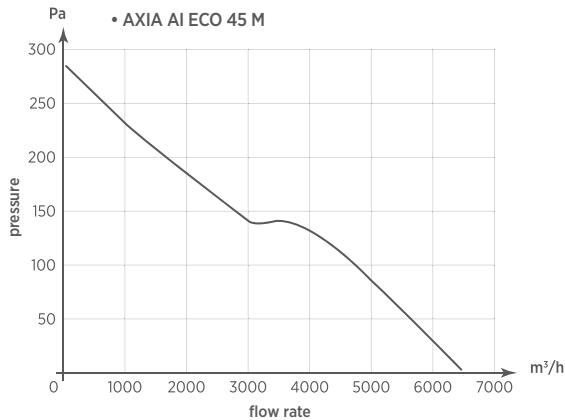
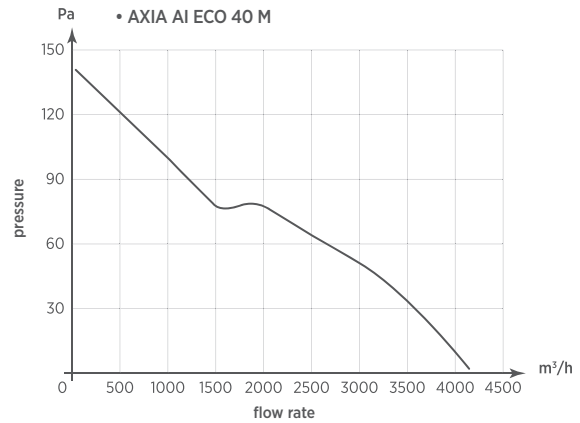
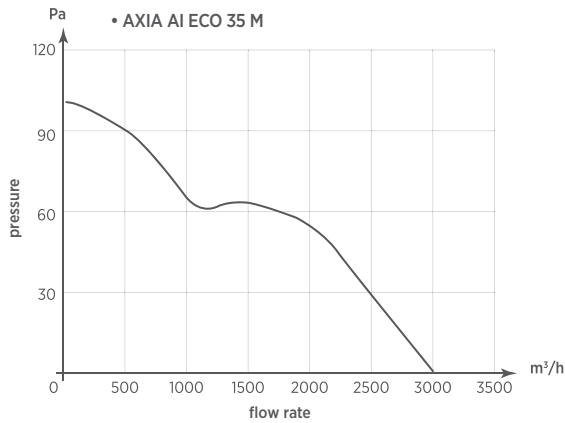
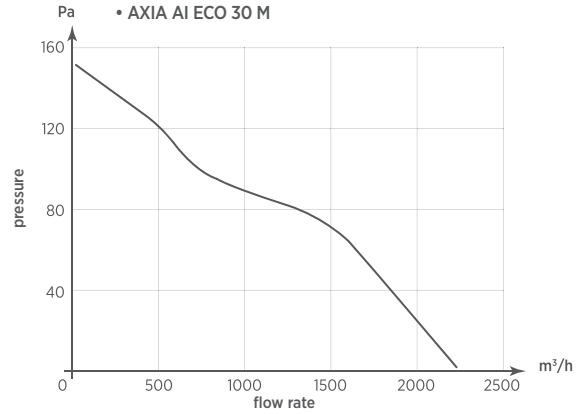
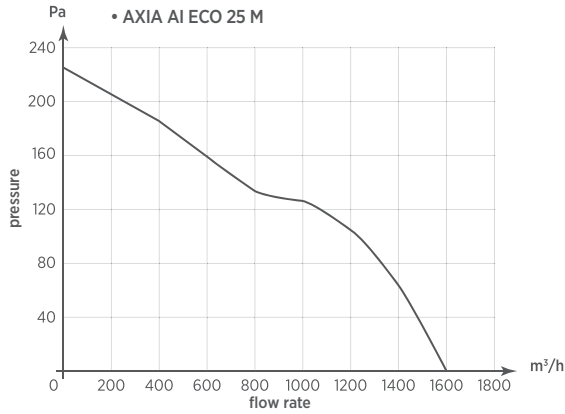

ACCESSORIES:
SEE PAGE 85



Controllers



Safety protection grille



Connection flange



Extension ring

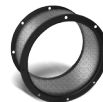

Flexible connection



Support

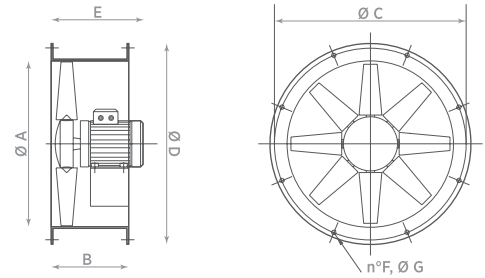

Model	ØA	B	ØC	ØD	E	F	ØG
AXIA AI HP 30	317	200	355	377	294	8	10
AXIA AI HP 35	355	200	395	421	271/294	8	10
AXIA AI HP 40	405	220	450	472	237/349	8	12
AXIA AI HP 45	451	250	500	530	378	8	12
AXIA AI HP 50	503	280	560	590	292/327	12	12
AXIA AI HP 55	560	280	620	650	384/419	12	12
AXIA AI HP 60	634	280	690	720	408/445/585	12	12
AXIA AI HP 70	711	280	770	800	360/371/397/437	16	12

AXIA AI HP

AXIAL DUCT FAN

High-performance ducted axial fans, designed for industrial and tertiary ventilation plants with round normalized ducts.

- The range is composed by 8 sizes, with capacities up to 24.000 m³/h.
- Impeller with high efficiency airfoil blades, variable pitch angle in still position, in plastic material or in die-cast aluminum alloy. Hub in die-cast aluminum alloy.
- Balancing according to UNI ISO 1940.

- Casing in steel sheet protected with epoxy painting.
- Fixing flanges according to UNIISO 6580/EUROVENT 1-2.
- Asynchronous electric motor, protection IP 55, class F insulated, form B3, service S1 construction according to the IEC/EEC (UNEL-MEC) standard.
- Higher sizes and performance are available on request.



POSITIONING

- Duct mounting

ENVIRONMENTS APPLICATION

AXIA AI HP series is suitable when large air capacities with relatively low pressures are required in duct mounted applications.

- Industrial and tertiary ventilation and conditioning systems.

- Mining and naval applications, evaporative towers, heat exchangers, cooling of electric and refrigerating equipments, etc.

TECHNICAL DATA

Model	Code	Motor	N° poles	Rev. per min. (RPM)	Voltage (Volt)	Frequency (Hz)	Flow rate (m ³ /h)	Max press (mm H ₂ O)	Max press. (Pa)	Power kW	Nom. Curr. (A) 230 V	400 V	IP Motor protection	Noisiness dB(A) _{2m}	Weight (kg)
AXIA AI HP 30 2M	0013100	Single phase	2	2800	230	50	3300	24	235	0,37	2,5	-	IP55	70	13
AXIA AI HP 30 4M	0013102	Single phase	4	1400	230	50	2450	8	78	0,09	0,9	-	IP55	53	13
AXIA AI HP 35 2M	0013104	Single phase	2	2800	230	50	4800	40	392	0,55	4	-	IP55	77	14
AXIA AI HP 35 4M	0013106	Single phase	4	1400	230	50	3000	9	88	0,12	1,1	-	IP55	55	14
AXIA AI HP 35 4M-P	0013108	Single phase	4	1400	230	50	3400	10	98	0,12	1,1	-	IP55	57	14
AXIA AI HP 40 2M	0013110	Single phase	2	2800	230	50	8000	38	373	1,1	7,5	-	IP55	79	16
AXIA AI HP 40 4M	0013112	Single phase	4	1400	230	50	3450	11	108	0,12	1,1	-	IP55	59	16
AXIA AI HP 40 4M-P	0013114	Single phase	4	1400	230	50	4550	12	118	0,18	1,6	-	IP55	62	16
AXIA AI HP 45 4M	0013116	Single phase	4	1400	230	50	5800	13	127	0,25	2,4	-	IP55	63	23
AXIA AI HP 45 4M-P	0013118	Single phase	4	1400	230	50	7500	15	147	0,37	3,1	-	IP55	74	23
AXIA AI HP 30 2T	0013101	Three phase	2	2800	400	50	3300	24	235	0,37	1,2	1	IP55	66	13
AXIA AI HP 30 4T	0013103	Three phase	4	1400	400	50	2450	8	78	0,09	0,7	0,38	IP55	53	13
AXIA AI HP 35 2T	0013105	Three phase	2	2800	400	50	4800	40	392	0,55	2,8	1,6	IP55	77	14
AXIA AI HP 35 4T	0013107	Three phase	4	1400	400	50	3000	9	88	0,12	0,7	0,4	IP55	55	14
AXIA AI HP 35 4T-P	0013109	Three phase	4	1400	400	50	3400	10	98	0,12	0,7	0,4	IP55	57	14
AXIA AI HP 40 2T	0013111	Three phase	2	2800	400	50	8000	38	373	1,1	4,5	2,6	IP55	79	16
AXIA AI HP 40 4T	0013113	Three phase	4	1400	400	50	3450	11	108	0,12	0,7	0,4	IP55	59	16
AXIA AI HP 40 4T-P	0013115	Three phase	4	1400	400	50	4550	12	118	0,18	1,0	0,6	IP55	62	16
AXIA AI HP 45 4T	0013117	Three phase	4	1400	400	50	5800	13	127	0,25	1,4	0,8	IP55	63	23
AXIA AI HP 45 4T-P	0013119	Three phase	4	1400	400	50	7500	15	147	0,37	2,1	1,2	IP55	68	23
AXIA AI HP 50 4T	0013121	Three phase	4	1400	400	50	6100	17	167	0,37	2,1	1,2	IP55	64	25
AXIA AI HP 50 4T-P	0013123	Three phase	4	1400	400	50	7500	18	177	0,55	2,8	1,6	IP55	69	25
AXIA AI HP 50 6T	0013125	Three phase	6	900	400	50	5700	9	88	0,18	1,2	0,7	IP55	58	25
AXIA AI HP 55 4T	0013127	Three phase	4	1400	400	50	8300	21	207	0,55	2,8	1,6	IP55	69	28
AXIA AI HP 55 4T-P	0013129	Three phase	4	1400	400	50	10700	21	207	0,75	3,5	2	IP55	70	28
AXIA AI HP 55 6T	0013131	Three phase	6	900	400	50	7700	10	98	0,25	1,7	1	IP55	61	28

Model	Code	Motor	N° poles	Rev. per min. (RPM)	Tension (Volt)	Frequency (Hz)	Max flow rate (m³/h)	Max press. (mm H ₂ O)	Max press. (Pa)	Power kW	Nom. Curr. (A)		IP Motor protection	Noisiness dB(A) _{2m}	Weight (kg)
											230 V	400 V			
AXIA AI HP 60 4T	0013135	Three phase	4	1400	400	50	10500	25	245	0,75	3,5	2	IP55	73	37
AXIA AI HP 60 4T-P	0013137	Three phase	4	1400	400	50	13200	22	217	1,1	4,8	2,8	IP55	75	37
AXIA AI HP 60 4T-DP	0013139	Three phase	4	1400	400	50	18000	25	245	2,2	8,7	5	IP55	80	37
AXIA AI HP 60 6T	0013141	Three phase	6	900	400	50	9200	13	128	0,37	2,2	1,3	IP55	66	37
AXIA AI HP 60 6T-P	0013143	Three phase	6	900	400	50	14400	17	165	0,75	3,8	2,2	IP55	88	37
AXIA AI HP 60 8T	0013145	Three phase	8	700	400	50	8500	7	69	0,18	1,4	0,8	IP55	60	37
AXIA AI HP 70 4T	0013147	Three phase	4	1400	400	50	15000	27	264	1,5	6,1	3,5	IP55	79	44
AXIA AI HP 70 4T-P	0013149	Three phase	4	1400	400	50	20000	26	256	2,2	8,7	5	IP55	81	44
AXIA AI HP 70 4T-DP	0013151	Three phase	4	1400	400	50	24000	28	277	2,7	8,7	6	IP55	81	44
AXIA AI HP 70 6T	0013153	Three phase	6	900	400	50	15400	14	137	0,75	3,8	2,2	IP55	68	44
AXIA AI HP 70 6T-P	0013155	Three phase	6	900	400	50	19200	17	167	1,5	5,2	3,3	IP55	69	44
AXIA AI HP 70 8T	0013157	Three phase	8	700	400	50	12000	9	87	0,37	2,6	1,4	IP55	61	44

FLOW CHARTS

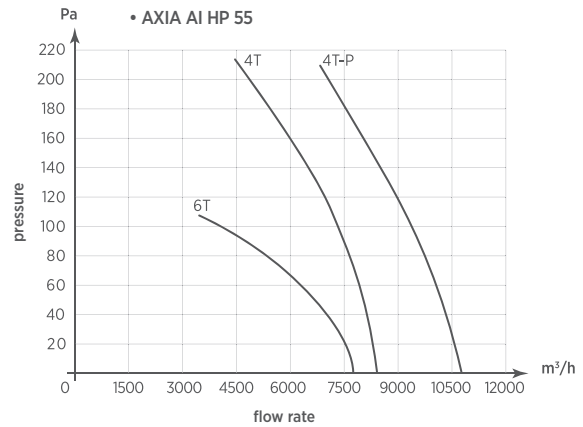
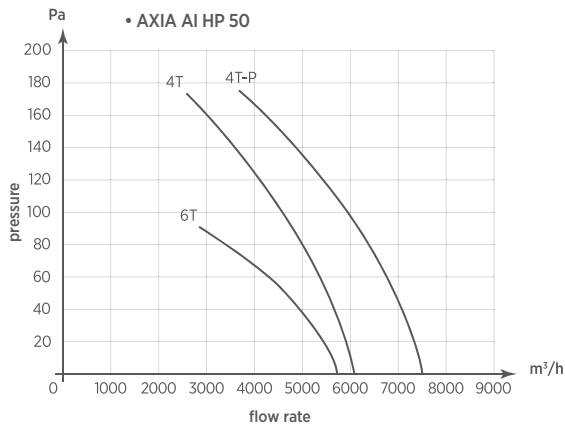
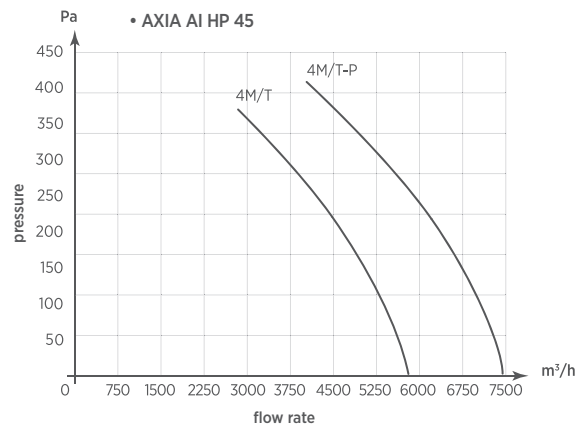
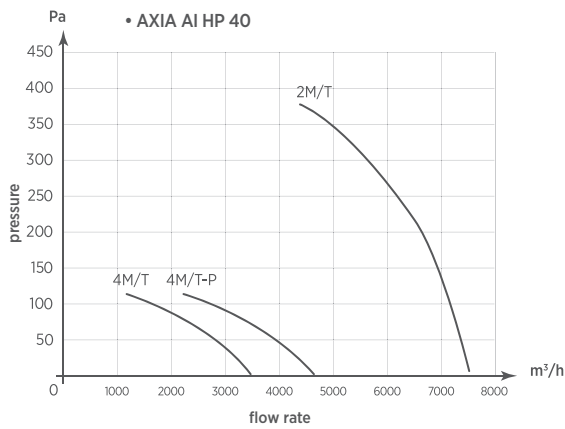
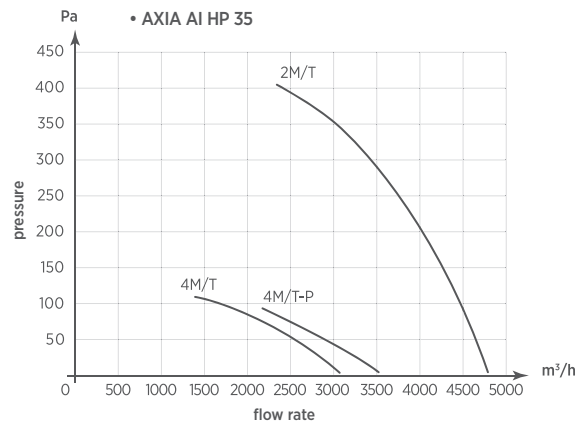
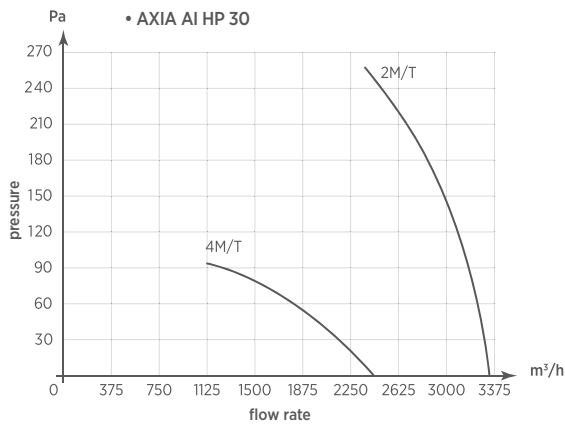

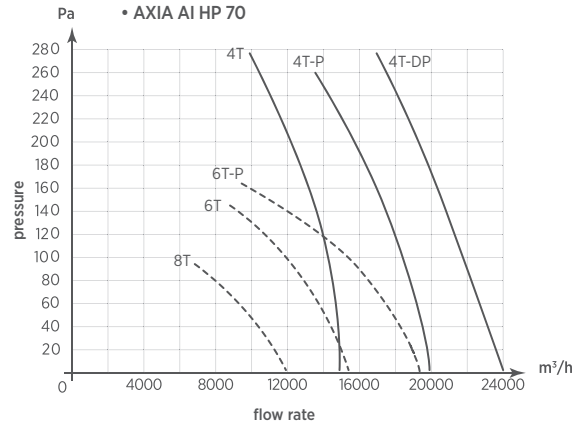
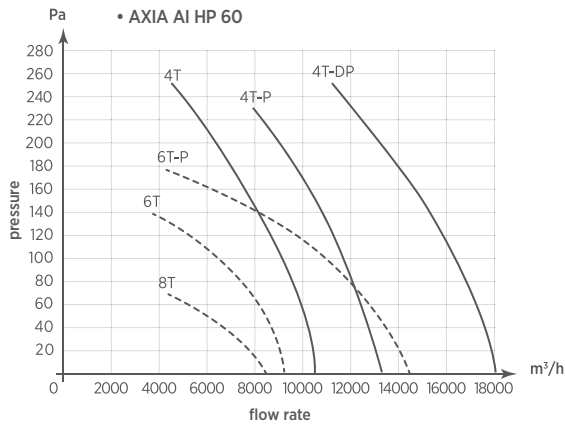

ACCESSORIES:
SEE PAGE 85



Controllers



Safety protection grille



Connection flange



Extension ring

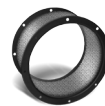

Flexible connection



Support

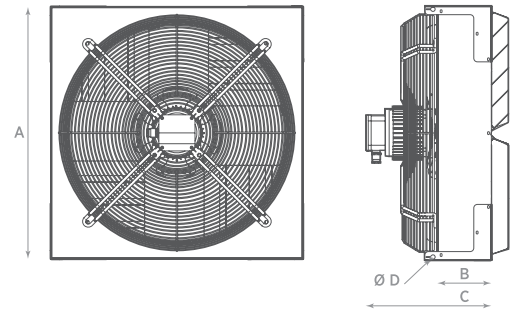
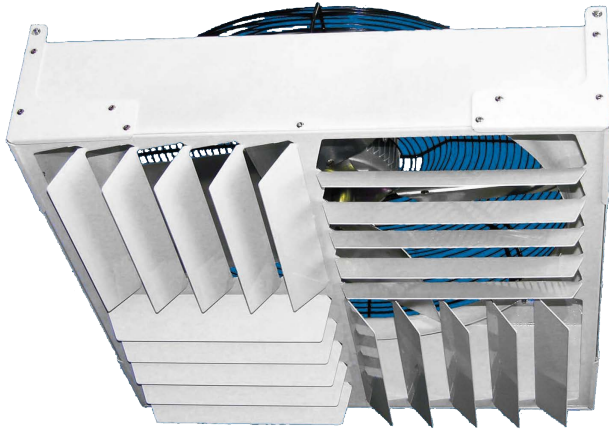

Model	A	B	C	ØD
AXIA DES 450 6M	550	150	315	12
AXIA DES 600 6M	700	150	345	12
AXIA DES 710 6M	800	200	385	12

DES

DESTRATIFIER



Air Destratifier suitable for installation in environments where the height of the ceiling is over 4 meters.

- Their main function is to prevent the formation of air layers with different temperatures through the air blending in the environment where installed;
- Composed of single phase axial fan, equipped with an aluminium balanced impeller, mounted on body in steel material painted, supplied with specific rings to be fixed in suspension. The lower part is equipped with adjustable deflector fins in order to regulate the airflow according to specific requirements;
- On winter: the hot air accumulated on the top of the environments is conveyed in the lower area heating it and reducing the relative humidity,

it contributes to energy saving with a reduction of heating expenses (up to 30%);

- On summer: the air movement creates fresh effect due to the body humidity evaporation. The relative humidity to the ground is reduced (up to 20%) due to the homogenization;
- The thermostat on the product allows to work automatically according to the air temperature;
- Ball bearing single phase class F insulation motor IP55 protected;
- Motor speed can be regulated through the industrial controllers (see accessories).

POSITIONING

- Ceiling mounting

ENVIRONMENTS APPLICATION

Suitable for installation in industrial environment such as:

- Industries
- Sheds and Warehouses

- Greenhouses and breeding
- Sports facilities
- Supermarkets and Shopping centers

TECHNICAL DATA

Model	Code	Motor	N° poles	Rev. per min. (RPM)	Voltage (Volt)	Frequency (Hz)	Flow rate (m ³ /h)	Power (W)	Nom. curr. (A) 230 V	IP Motor protection	Noisiness dB(A) _{1m}	Weight (Kg)
AXIA DES 450 6M	0024910	single phase	6	900	230	50-60	3500	100	0,6	IP55	58	14
AXIA DES 600 6M	0024920	single phase	6	900	230	50-60	7300	210	1,5	IP55	59	24
AXIA DES 710 6M	0024930	single phase	6	900	230	50-60	11300	750	4	IP55	60	36

FLOW CHARTS

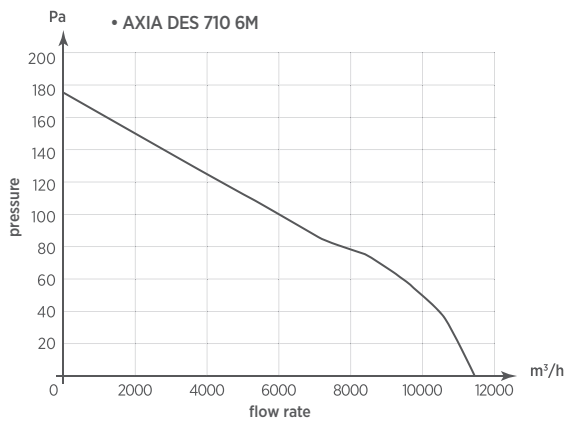
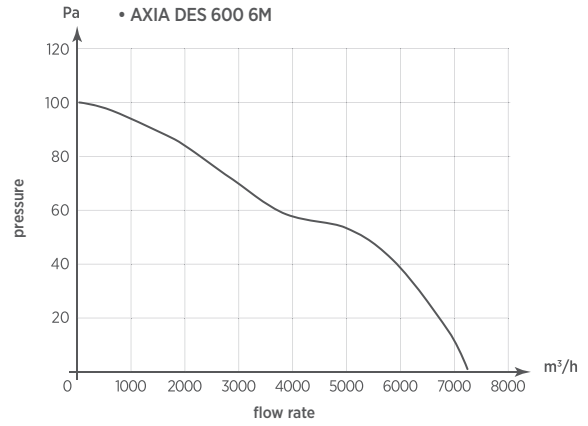
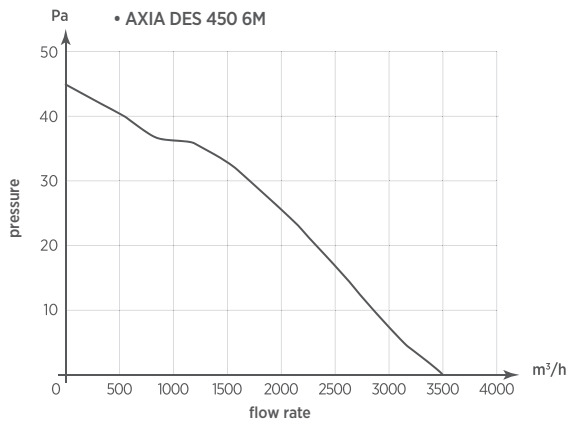

ACCESSORIES:
SEE PAGE 85



Controllers

HOW TO SELECT THE CORRECT PRODUCT

The correct model can be selected in accordance with the height of the premises and how high the destratifier needs to be installed. Higher is the destratifier installed, larger must be its size. An approximate method to define how many destratifiers must be installed in a premises consists in calculating 5 air exchanges per hour by means of the following formula:

$$\text{N}^\circ \text{ of diffusers} = [5 \times (\text{m}^3 \text{ environment}) / \text{diffuser capacity m}^3/\text{h}$$

The maximum installation height of each model as shown below.

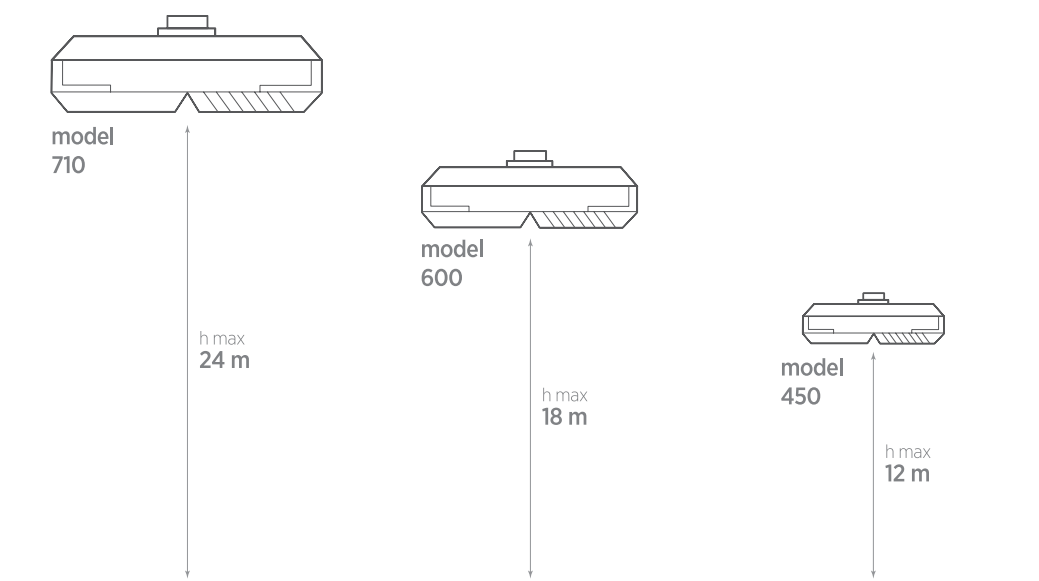

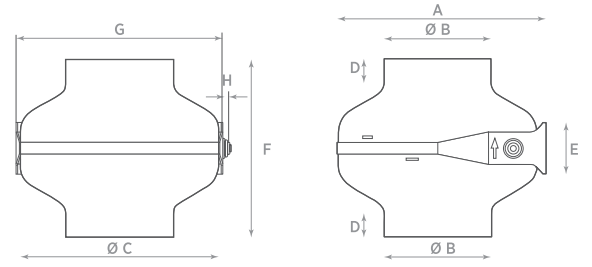

Model	A	ØB	ØC	D	*E	F	G	H
TURBO 100 ES	287	98	275	17	70	242	282	12
TURBO 100	287	98	275	17	70	242	282	12
TURBO 125 ES	287	123	275	24	70	242	282	12
TURBO 125	287	123	275	24	70	242	282	12
TURBO 150 ES	287	148	275	32	70	242	282	12
TURBO 150	287	148	275	32	70	242	282	12
TURBO 160 ES	287	158	275	35	70	242	282	12
TURBO 160	354	158	345	24	84	272	345	12
TURBO 200 ES	354	198	345	34	84	272	345	12
TURBO 200	354	198	345	34	84	272	345	12
TURBO 250	354	248	345	48	84	272	345	12
TURBO 315 ES	354	313	345	48	84	272	345	12
TURBO 315	354	313	345	48	84	272	345	12



CE IPX4 T 40



TURBO CENTRIFUGAL FAN

In Line centrifugal high performances fans to convey air or fumes through ducts.

- Suitable for domestic, commercial and industrial environments;
- Max temperature of extracted air: 55°C;
- The range is composed by 13 models in standard version with high performances and in ES version with reduced noise level and energy consumption;
- Ball bearing motor protected by a non self resetting thermal cut-out
- Zinc plated steel frame, high resistance motor support with incorporated

- airflow fins;
- Integrated mounting bracket for easy and quick installation;
- Holes provided in the bracket allow mounting with cords;
- Electrical box IP54 protected;
- Product IPX4 protected;
- Double insulated product, without ground wire for fast connection;
- In accordance with EN 60335-2-80;
- Motor speed can be regulated through optional controller.

POSITIONING

- Duct mounting

ENVIRONMENTS APPLICATION

Suitable for domestic, commercial and industrial environment such as:

- Bathroom
- Kitchens
- Offices
- Factories
- Shops
- Gymnasiums
- Bars & Restaurants

TECHNICAL DATA

Model	Code	Motor	N° poles	Rev. per min.	Voltage (Volt)	Frequency (Hz)	Flow rate (m³/h)	Max press (mm H ₂ O)	Max press (Pa)	Power (W)	Nom. curr. (A) 230 V	IP Motor protection	Noisiness dB(A) _{1m}	Weight (Kg)
TURBO 100 ES	0037100	single phase	2	2000	220-240	50	210	30	294	55	0,25	IP54	45	3,0
TURBO 100	0037000	single phase	2	2600	220-240	50	270	30	294	75	0,35	IP54	53	3,0
TURBO 125 ES	0037400	single phase	2	1850	220-240	50	290	29	285	55	0,25	IP54	45	3,0
TURBO 125	0037300	single phase	2	2530	220-240	50	400	29	285	75	0,38	IP54	52	3,0
TURBO 150 ES	0037700	single phase	2	1850	220-240	50	370	27	265	55	0,25	IP54	42	3,0
TURBO 150	0037600	single phase	2	2530	220-240	50	500	29	285	75	0,38	IP54	52	3,0
TURBO 160 ES	0037800	single phase	2	2500	220-240	50	540	28	275	75	0,38	IP54	52	3,0
TURBO 160	0037900	single phase	2	2500	220-240	50/60	710	37	363	90	0,43	IP54	56	4,5
TURBO 200 ES	0038000	single phase	2	2550	220-240	50/60	730	30	294	90	0,42	IP54	56	4,5
TURBO 200	0038100	single phase	2	2550	220-240	50/60	1050	55	540	180	0,78	IP54	58	5,5
TURBO 250	0038300	single phase	2	2590	220-240	50/60	1200	56	549	180	0,78	IP54	59	5,5
TURBO 315 ES	0038500	single phase	2	2600	220-240	50/60	1250	50	490	180	0,78	IP54	59	5,5
TURBO 315	0038400	single phase	2	2500	220-240	50/60	1400	65	638	280	1,24	IP54	59	6,0

FLOW CHARTS

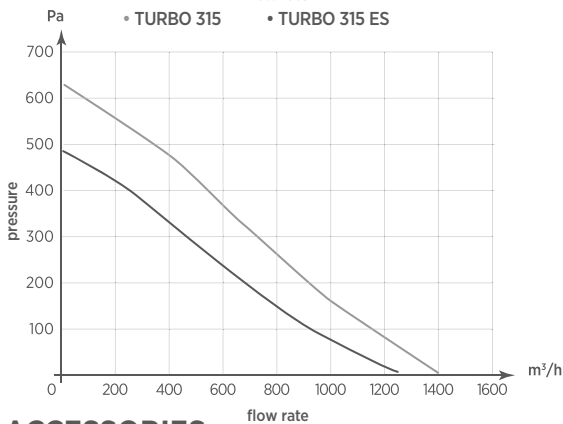
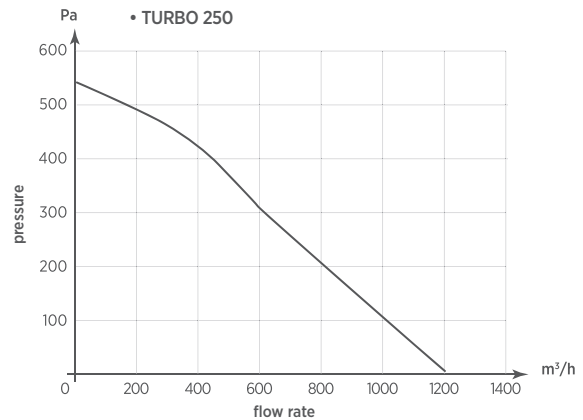
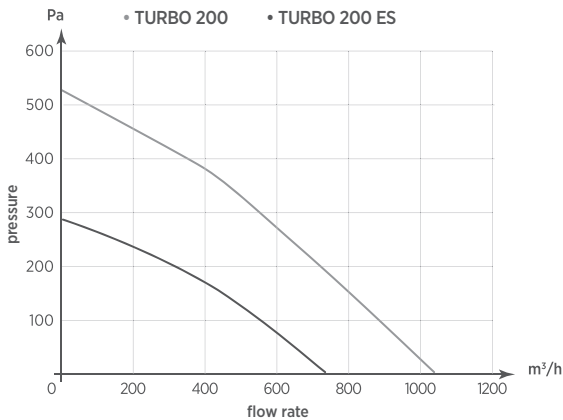
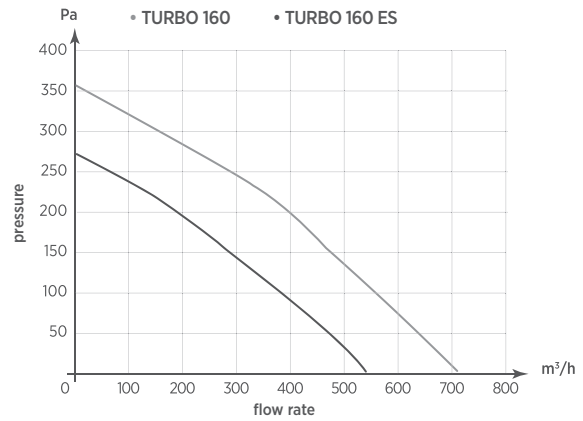
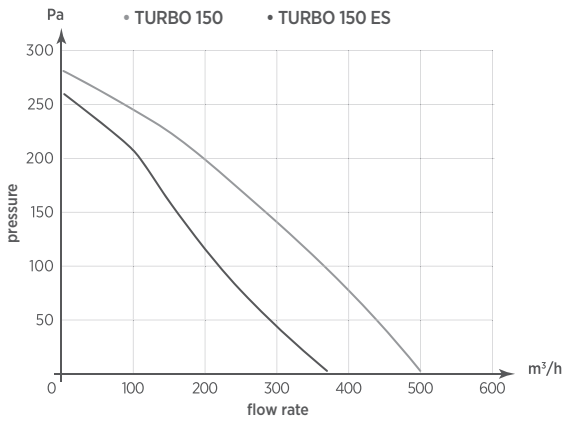
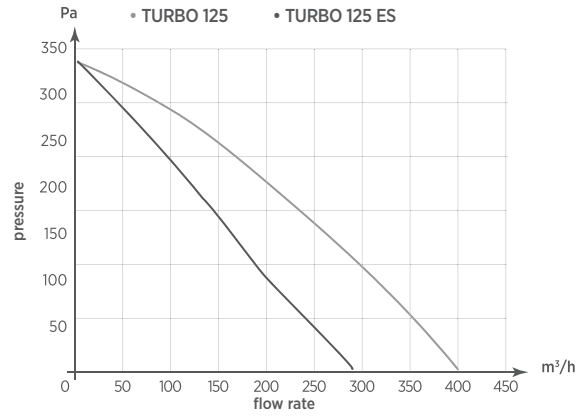
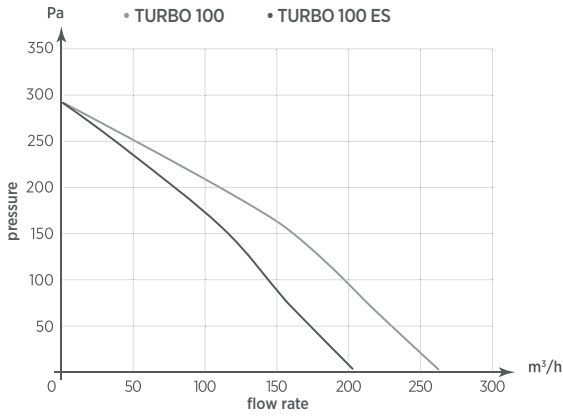

ACCESSORIES:

SEE PAGE 85



Controllers



Duct clamp



Protection grille



Backdraught shutter

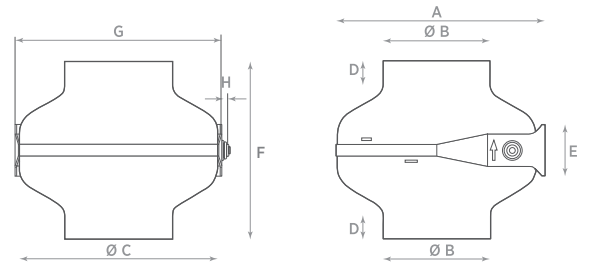

Model	A	Ø B	Ø C	D	*E	F	G	H
TURBOPLAST 100	287	98	275	17	70	242	282	12
TURBOPLAST 125	287	123	275	24	70	242	282	12
TURBOPLAST 150	287	148	275	32	70	242	282	12
TURBOPLAST 160	287	158	275	33	70	242	282	12

TURBOPLAST CENTRIFUGAL FAN



CE IPX4 T 40



In Line centrifugal high performances fans to convey air or fumes through ducts.

- Suitable for domestic, commercial and industrial environments;
- Max temperature of extracted air: 55°C;
- Frame completely made of V0 polymeric material;
- High resistance motor support with incorporated air fins;
- Integrated mounting bracket for easy and quick installation;
- Holes provided in the bracket allow mounting with cords;

- Electrical box IP54 protected;
- Product IPX4 protected;
- Provided with incorporated safety grilles both on inlet and outlet openings, that can be easily removed for duct installation to increase product's airflow (see table below);
- Double insulated product, without ground wire for fast connection;
- Motor speed can be regulated through optional controller;
- In accordance with EN 60335-2-80.

POSITIONING

- Duct mounting

ENVIRONMENTS APPLICATION

Suitable for Domestic, Commercial and Industrial environment such as:

- Bathroom
- Kitchens
- Offices

- Factories
- Shops
- Gymnasiums
- Bars & Restaurants

TECHNICAL DATA

Model	Code	Motor	N° poles	Rev. per min. (RPM)	Voltage (Volt)	Frequenza (Hz)	Flow rate (m³/h)		Max press (mm H₂O)	Max press (Pa)	Potenza (W)	Nom. curr. (A) 230 V	IP Motor protection	Noisiness dB(A) _{1m}	Weight (Kg)
							1 grille	2 grille							
TURBOPLAST 100	0037200	single phase 2	2	2680	220-240	50	250	220	31	304	60	0,3	IP54	48	2,6
TURBOPLAST 125	0037500	single phase 2	2	2560	220-240	50	370	310	30	294	60	0,33	IP54	48	2,6
TURBOPLAST 150	0038600	single phase 2	2	2450	220-240	50	460	400	29	285	60	0,39	IP54	49	2,6
TURBOPLAST 160	0038700	single phase 2	2	2450	220-240	50	500	450	29	285	60	0,3	IP54	50	2,6

FLOW CHARTS



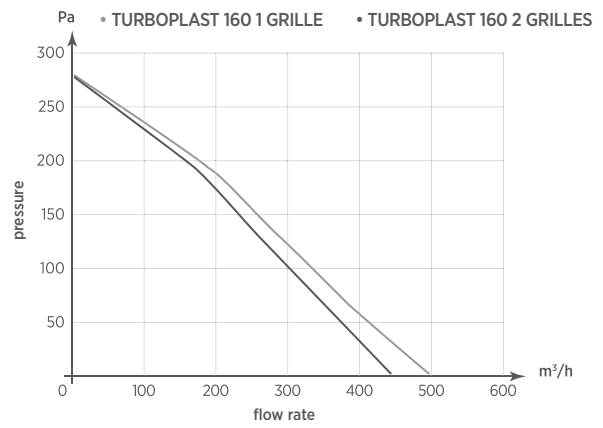
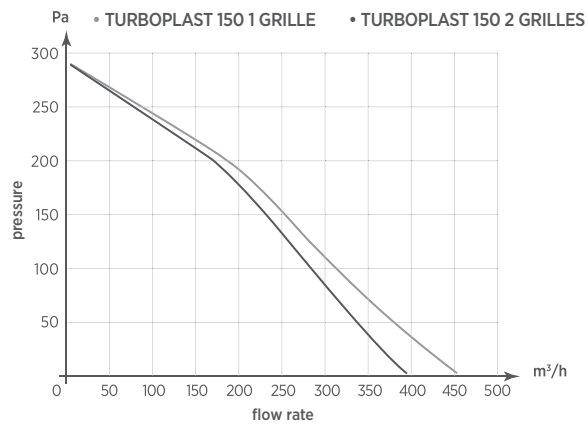

ACCESSORIES:
SEE PAGE 84



Controllers



Duct clamp



Grille



Backdraught shutter

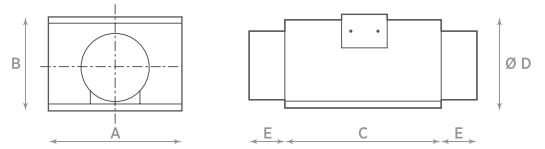

Model	A	B	C	Ø D	E
IL R 100	300	200	350	100	80
IL R 125	300	200	350	125	80
IL R 150	300	200	350	150	80
IL R 200	350	230	350	200	80
IL R 250	350	280	400	250	80

IL R

COMPACT IN LINE CENTRIFUGAL FAN

Compact centrifugal fans designed for easy insertion in the ventilation ducts with round section to be installed in false ceilings and/or wall.

- Max working temperature: 50°C;
- Backward bladed centrifugal fan;
- External rotor motor equipped with ball bearing, protected by non self resetting thermal cut-out ;

- Galvanized sheet steel body, fixing bracket supplied as standard;
- Equipped with external box power supply;
- In compliance with European Directive and to the Standards UNI EN ISO 13857 and 12499; CEI EN 60204-1;
- Adjustable speed through industrial controllers (optional).



POSITIONING

- False Ceiling mounting
- Floor mounting

ENVIRONMENTS APPLICATION

Suitable for installation in false ceilings or in small areas such as:

- Houses with central plant ventilation
- Shops, offices
- Gyms
- Workshops, small workshops

TECHNICAL DATA

Model	Code	Motor	N° poles	Rev. per min. (RPM)	Voltage (Volt)	Frequency (Hz)	Flow rate (m³/h)	Max press (mm H ₂ O)	Max press (Pa)	Power (W)	Nom. curr. (A)	Protection degree	Noisiness dB(A) _{2m}	Weight (Kg)
IL R 100	0012500	Single phase	2	2200	230	50-60	500	15,3	150	80	0,37	IP44	53	8
IL R 125	0012502	Single phase	2	2200	230	50-60	580	20,4	200	80	0,37	IP44	55	8
IL R 150	0012504	Single phase	2	2700	230	50-60	880	28,5	280	85	0,43	IP44	56	8
IL R 200	0012506	Single phase	2	2650	230	50-60	180	42,8	420	150	0,65	IP44	65	11
IL R 250	0012508	Single phase	2	2500	230	50-60	1500	51,0	500	165	0,73	IP44	64	12
IL R 315	0012510	Single phase	2	2650	230	50-60	1650	58,1	570	230	1,05	IP44	70	16

FLOW CHARTS

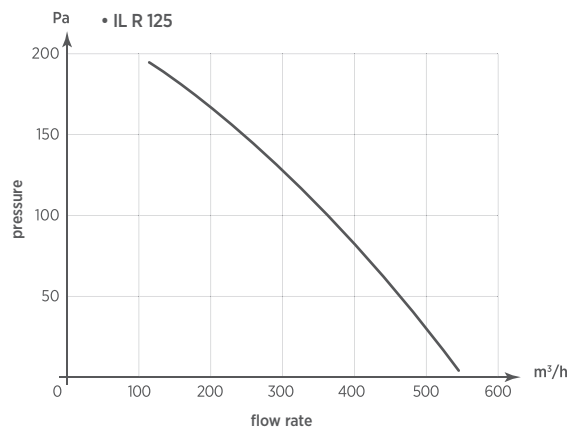
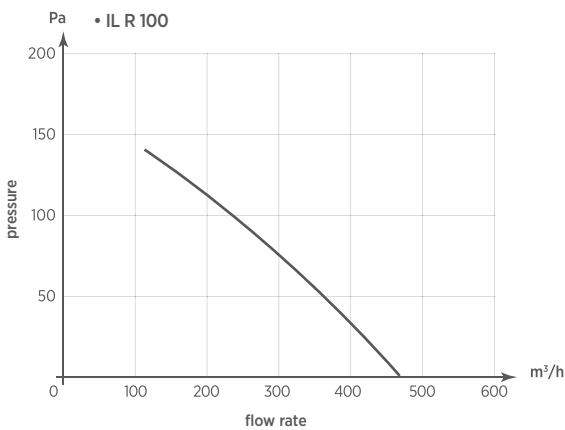

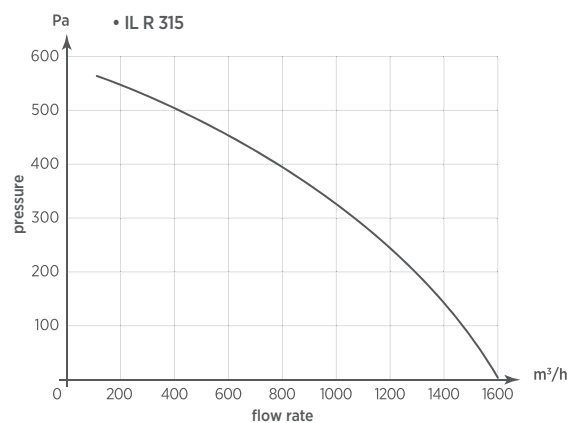
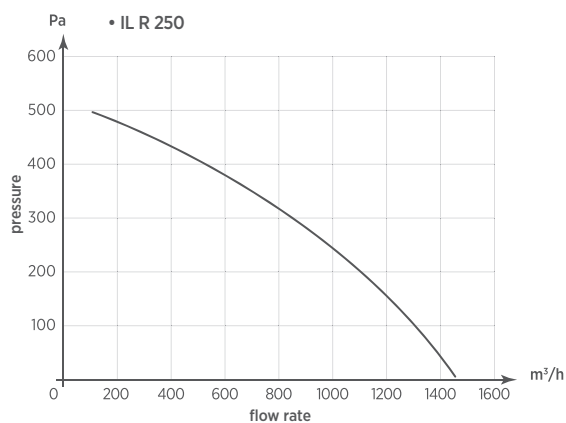
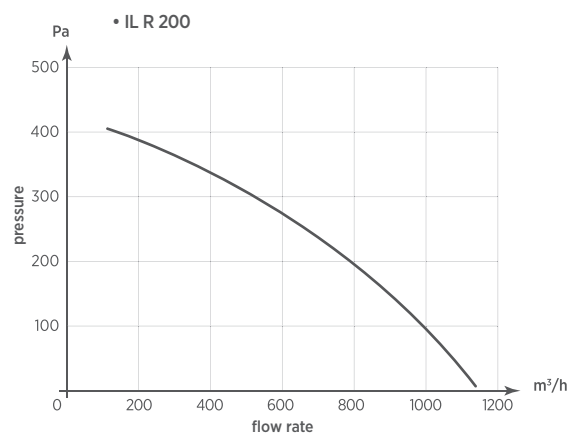
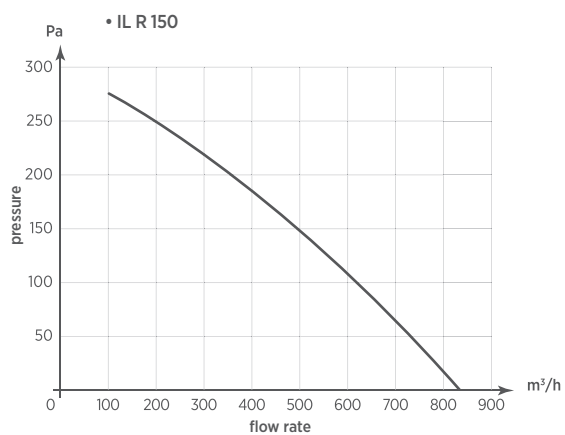

ACCESSORIES:

SEE PAGE 85



Controllers



Duct clamp



Grille



Backdraught shutter

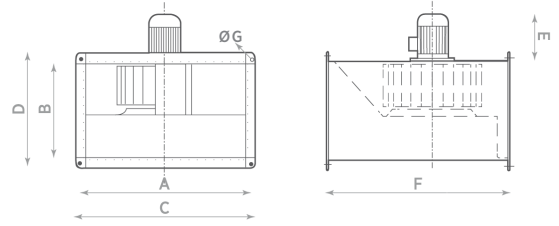

Model	A	B	C	D	E	F	ØG
IL S 200	400	200	440	240	207	500	9
IL S 225	500	250	560	310	207	560	9
IL S 250	500	300	560	360	233	560	9
IL S 280	600	300	560	360	233	710	9
IL S 310	600	350	660	410	283	710	9
IL S 350	700	400	760	460	322	780	9
IL S 400	800	500	860	560	322	880	9
IL S 450	1000	500	1060	560	345	980	9

IL S CENTRIFUGAL FAN



Centrifugal fans designed for easy insertion in the ventilation ducts with square section to be installed in false ceilings and/or wall. The motor external to the airflow allows high reliability.

- Max working temperature: 50°C;
- Zinc plated steel forward centrifugal impeller ;
- Galvanized sheet steel body with flanges having standardized dimensions;

- Self ventilated UNEL-MEC motor, Class F, IP55 external to the air flow;
- Equipped with power supply cable gland;
- In compliance with European Directive and to the Standards UNI EN ISO 13857 and 12499; CEI EN 60204-1;
- Adjustable speed through industrial controllers (optional).

POSITIONING

- Ceiling mounting

ENVIRONMENTS APPLICATION

Suitable for installation in commercial and tertiary environment such as:

- Kitchens and canteens
- Shops, offices, workshops
- Sports facilities
- Supermarkets and shopping centers
- Storage and warehouse.

TECHNICAL DATA

Model	Code	Motor	N° poles	Rev. per min. (RPM)	Voltage (Volt)	Frequency (Hz)	Flow rate (m³/h)	Max press. (mm H₂O)	Max press. (Pa)	Power (kW)	Nom. Curr. (A)		IP Motor protection	Noisiness dB(A) _{1m}	Weight (Kg)
											230 V	400 V			
IL S 200 4M	0012402	single phase	4	1400	230	50	1250	26	255	0,25	2,4	-	IP55	66	22
IL S 200 6M	0012404	single phase	6	900	230	50	900	13	128	0,18	1,8	-	IP55	60	22
IL S 225 4M	0012406	single phase	4	1400	230	50	1800	37	363	0,37	3,0	-	IP55	69	35
IL S 225 6M	0012408	single phase	6	900	230	50	1300	15	147	0,18	1,8	-	IP55	66	35
IL S 250 4M	0012410	single phase	4	1400	230	50	2850	47	461	0,55	5,7	-	IP55	72	40
IL S 250 6M	0012412	single phase	6	900	230	50	1750	20	196	0,18	1,8	-	IP55	67	40
IL S 280 4M	0012414	single phase	4	1400	230	50	4000	53	520	0,75	6,0	-	IP55	76	43
IL S 280 6M	0012416	single phase	6	900	230	50	2400	25	245	0,75	2,4	-	IP55	68	43
IL S 200 4T	0012401	three phase	4	1400	400	50	1250	26	255	0,25	1,3	0,8	IP55	66	22
IL S 200 6T	0012403	three phase	6	900	400	50	900	13	128	0,18	1,2	0,7	IP55	60	22
IL S 225 4T	0012405	three phase	4	1400	400	50	1800	37	363	0,37	1,8	1,1	IP55	69	35
IL S 225 6T	0012407	three phase	6	900	400	50	1300	15	147	0,18	1,2	0,7	IP55	66	35
IL S 250 4T	0012409	three phase	4	1400	400	50	2850	47	461	0,55	2,6	1,5	IP55	72	40
IL S 250 6T	0012411	three phase	6	900	400	50	1750	20	196	0,18	1,2	0,7	IP55	67	40
IL S 280 4T	0012413	three phase	4	1400	400	50	4000	53	520	0,75	3,1	1,8	IP55	76	43
IL S 280 6T	0012415	three phase	6	900	400	50	2400	25	245	0,25	1,6	0,9	IP55	68	43
IL S 310 4T	0012417	three phase	4	1400	400	50	5750	72	706	1,50	5,6	3,2	IP55	77	55
IL S 310 6T	0012419	three phase	6	900	400	50	3730	33	324	0,37	2,1	1,2	IP55	69	55
IL S 350 4T	0012421	three phase	4	1400	400	50	9400	99	971	3,00	11,0	6,4	IP55	80	85
IL S 350 6T	0012423	three phase	6	900	400	50	5600	45	441	1,10	4,9	2,8	IP55	71	85
IL S 350 8T	0012425	three phase	8	700	400	50	4700	26	255	0,37	2,4	1,4	IP55	70	85
IL S 400 6T	0012427	three phase	6	900	400	50	8200	54	530	1,50	6,5	3,7	IP55	74	92
IL S 400 8T	0012429	three phase	8	700	400	50	6500	32	314	0,55	3,6	2,1	IP55	71	92
IL S 450 6T	0012431	three phase	6	900	400	50	12500	72	706	2,20	9,2	5,3	IP55	76	120
IL S 450 8T	0012433	three phase	8	700	400	50	9000	42	412	1,10	5,7	3,3	IP55	72	120

FLOW CHARTS

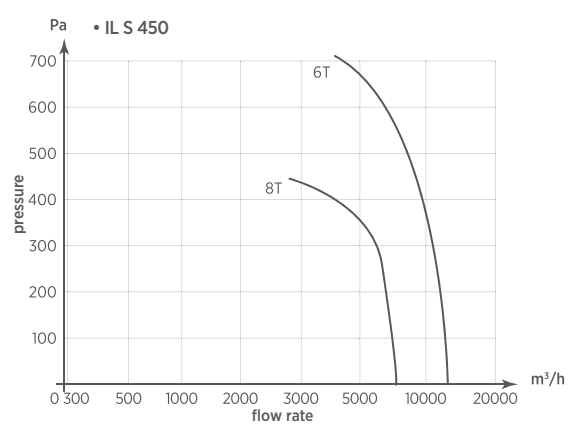
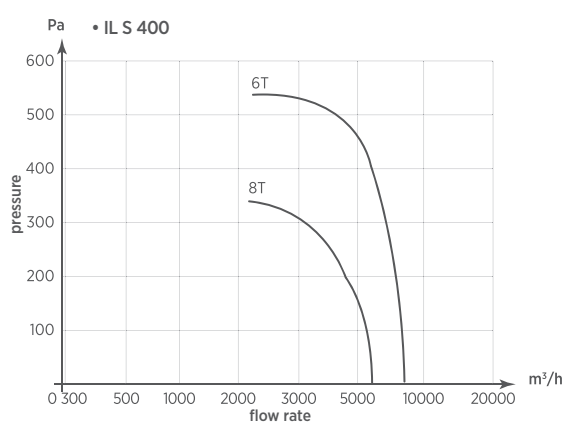
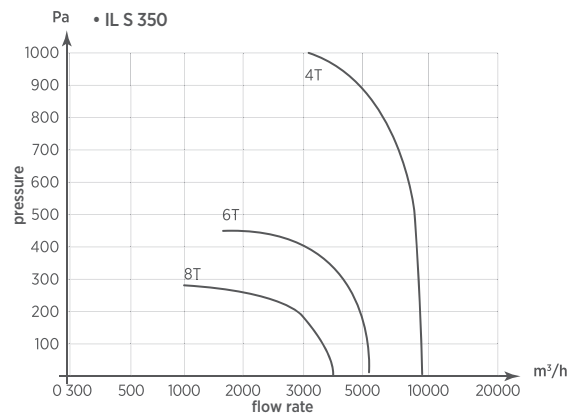
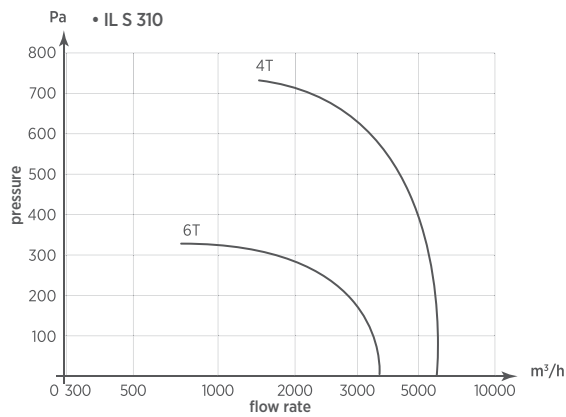
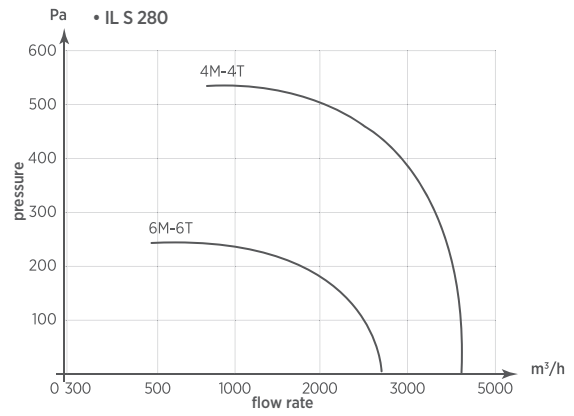
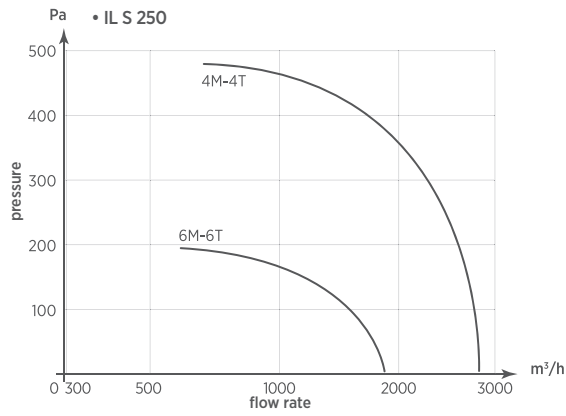
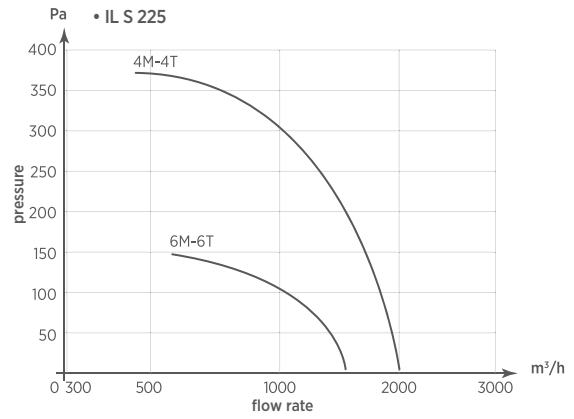
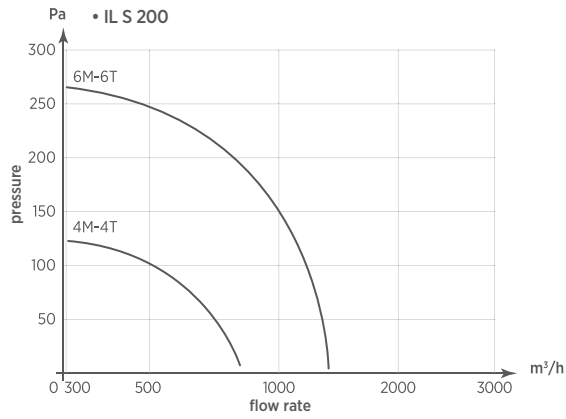

ACCESSORIES:
SEE PAGE 85



Controllers

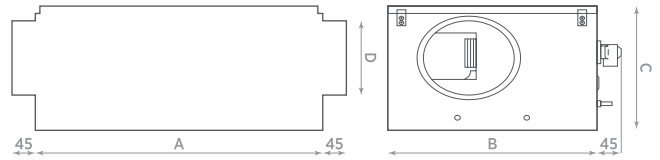

Model	A	B	C	D	H°
IL C 125	500	365	265	125	45
IL C 160	500	365	265	160	45
IL C 200	500	365	330	200	45
IL C 250	600	468	330	250	45
IL C 315	850	586	432	315	45
IL C 400	892	650	475	400	45
IL C 500	832	777	585	500	45
IL C 630	1090	952	705	630	45

IL C CENTRIFUGAL FAN



- Max temperature of extracted Air 50°C
- Balanced centrifugal fan, directly coupled to the motor
- Zinc plated steel body
- Sound deadening vibration reducing coating

- Equipped with power supply cable gland
- In compliance with European Directive and to the Standards UNI EN ISO 13857 and 12499; CEI EN 60204-1
- Adjustable speed through industrial controllers (optional)

POSITIONING

- Ceiling mounting
- Floor mounting

ENVIRONMENTS APPLICATION

Suitable for installation in commercial and tertiary environment such as:

- Residential houses with centralized ventilation system
- Shops, offices
- Gyms
- Workshops
- Sports facilities
- Supermarkets and shopping centers
- Storage and warehouse

TECHNICAL DATA

Model	Code	Motor	N° poles	Rev. per min. (RPM)	Voltage (V)	Frequency (Hz)	Flow rate (m³/h)	Max press. (mm H ₂ O)	Max press. (Pa)	Power (W)	Nom. curr. (A)		Protection degree	Noisiness dB(A) _{2m}	Weight (Kg)
											230 V	400 V			
IL C 125 2M	0013500	single phase	2	1450	230	50-60	480	27,5	270	0,08	0,45	-	IP42	23,0	12
IL C 160 2M	0013501	single phase	2	1450	230	50-60	650	31,6	310	0,08	0,45	-	IP42	44,5	12
IL C 200 2M	0013502	single phase	2	1550	230	50-60	1100	43,3	425	0,23	1,10	-	IP42	43,3	14
IL C 250 2M	0013503	single phase	2	1560	230	50-60	1400	43,3	425	0,28	1,15	-	IP42	49,7	19
IL C 315 4M	0013504	single phase	4	1350	230	50-60	2400	43,3	425	0,80	4,00	-	IP54	52,7	44
IL C 400 4M	0013505	single phase	4	1380	230	50-60	3900	51	500	1,00	4,40	-	IP54	51,7	58
IL C 500 4M	0013506	single phase	4	1380	230	50-60	4250	56	550	1,10	4,00	-	IP54	55,2	73
IL C 500 4T	0013507	three phase	4	1310	230/400	50-60	4800	53,5	525	1,62	-	2,10	IP54	61,0	95
IL C 630 4T	0013508	three phase	4	1420	230/400	50-60	10500	91,7	900	4,00	-	3,70	IP54	54,7	115

FLOW CHARTS

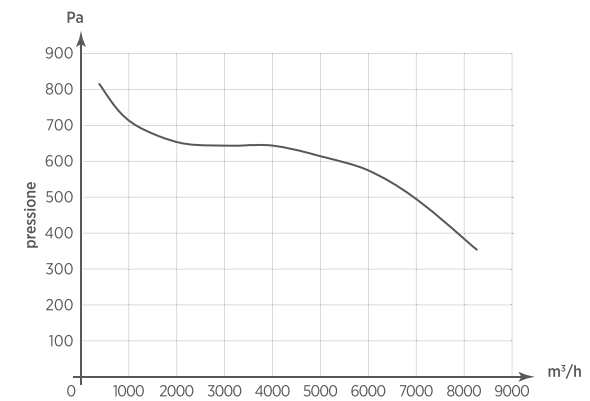
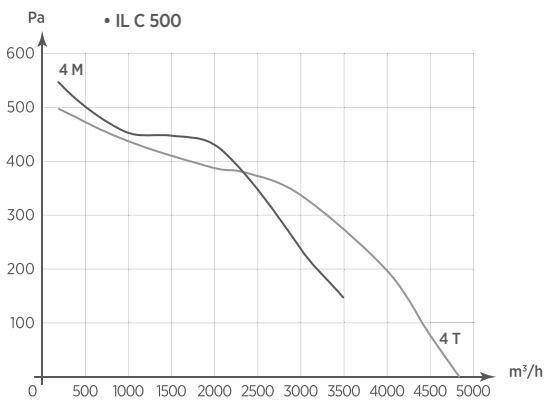
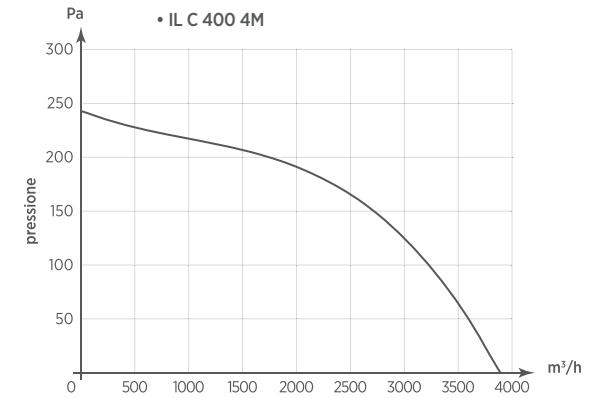
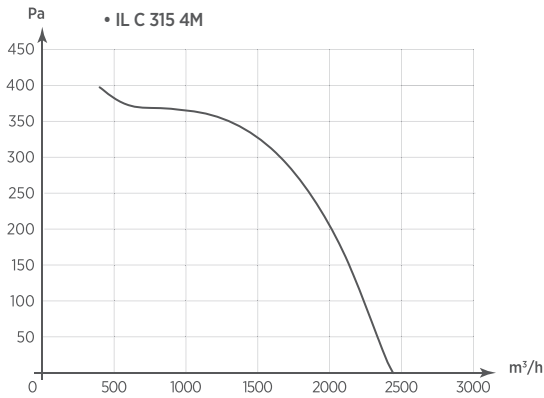
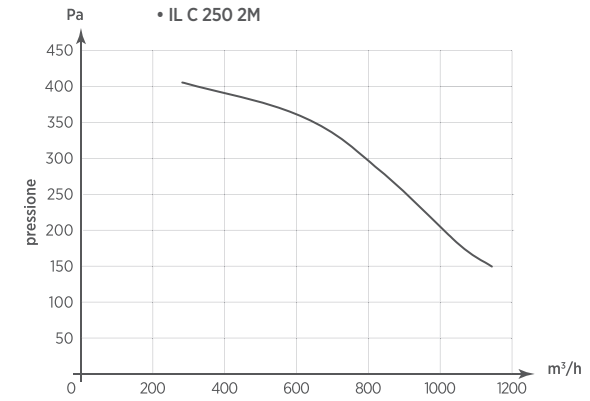
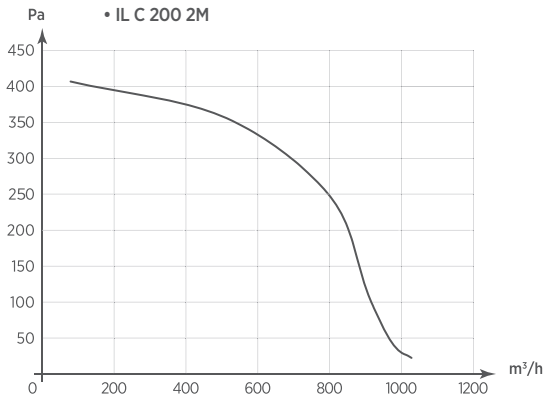
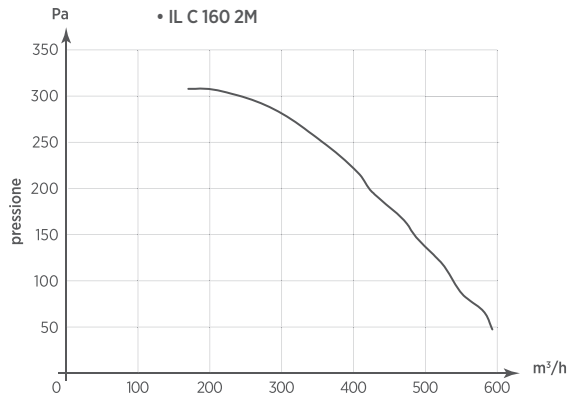
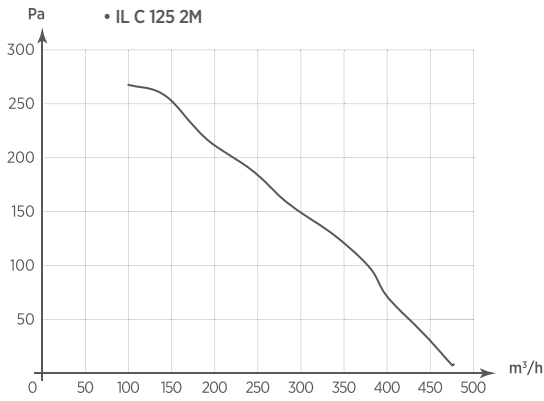

ACCESSORIES:
SEE PAGE 85



Controllers

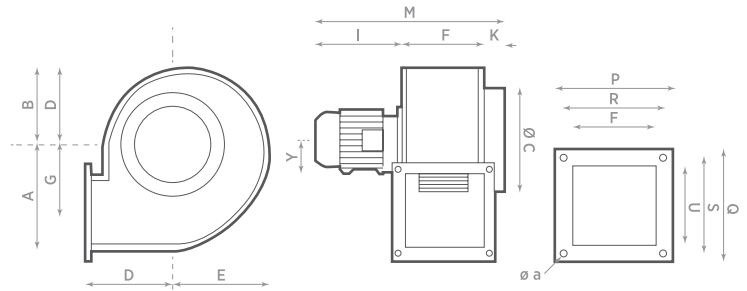

Model	A	B	ØC	D	E	F	G	Y	K	I	M	P	Q	R	S	T	U	Øa
CB 210	80	66	68	86	72	60	50	-	-	110	170	100	100	85	85	58	58	5,7
CB 220	95	76	90	105	80	77	60	-	-	121	198	115	110	95	90	71	64	6,8
CB 230	139	108	180	127	122	94	91	63	42	190	326	135	135	114	114	88	90	8,2
CB 240	172	128	200	146	150	112	117	71	45	210	367	152	152	126	126	105	105	8,2

CB CENTRIFUGAL FAN



Centrifugal duct fans to extract air and fumes through medium/long sized ducts.

- Suitable for application on machines where a forced ventilation or air suction is required;
- Temperature of extracted air: 50°C;
- Steel plated frame protected by an epoxy-based anticorrosive paint and aluminium centrifugal impeller statically and dynamically balanced;
- Suitable to overcome high pressure losses due to ducts resistance;

- Standard product supplied with impeller housing position CCW 270, different positions available on request (see table on page 89);
- Motor speed can be regulated through industrial controllers (see accessories);
- Models CB 230 and CB 240 supplied with ball bearing motor, IP55 protected;
- In accordance with the essential requirements of 2006/42/EC Directive concerning machines and European Standards UNI EN ISO 13857; UNI EN ISO 12499; CEI EN 60204-1.

POSITIONING

- Wall mounting

ENVIRONMENTS APPLICATION

Suitable for installation in Commercial, industrial and tertiary environment:

- Kitchens and Canteens;
- Shops;
- Offices;
- Workshops;
- Sports facilities;
- Supermarkets and Shopping Centers;
- Warehouses;
- Factories;
- Machinery

TECHNICAL DATA

Model	Code	Motor	N° poles	Rev. per min. (RPM)	Voltage (Volt)	Frequency (Hz)	Flow rate (m³/h)	Max press. (mm H ₂ O)	Max press. (Pa)	Power (W)	Nom. curr. (A)		IP Motor protection	Noisiness dB(A) _{1m}	Weight (Kg)
											230 V	400 V			
CB 210 2M	0041000	single phase	2	2800	230	50	210	22	216	67	0,29	-	IP22	64	2,5
CB 220 2M	0041200	single phase	2	2500	230	50	380	35	343	115	0,49	-	IP22	68	3,5
CB 230 2M	0041400	single phase	2	2750	230	50	1000	66	650	400	1,8	-	IP55	76	8,5
CB 240 2M	0041600	single phase	2	2750	230	50	1450	90	883	850	4,3	-	IP55	83	9,0
CB 210 2T	0041100	three phase	2	2800	230/400	50	210	22	216	67	0,26	0,15	IP22	64	2,5
CB 220 2T	0041300	three phase	2	2500	230/400	50	380	35	343	110	0,36	0,21	IP22	68	3,0
CB 230 2T	0041500	three phase	2	2750	230/400	50	1000	66	650	400	1,4	0,8	IP55	76	7,0
CB 240 2T	0041700	three phase	2	2750	230/400	50	1450	90	883	800	2,73	1,57	IP55	83	9,0

FLOW CHARTS

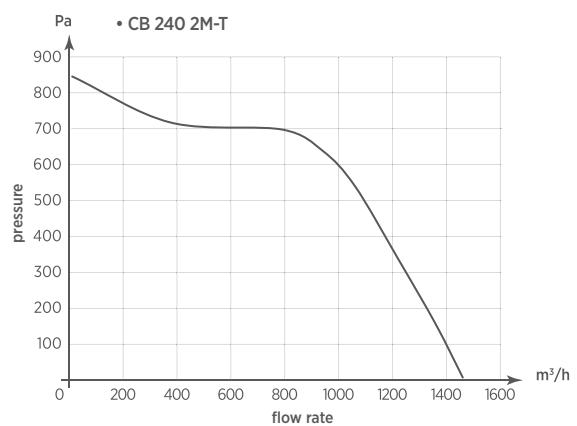
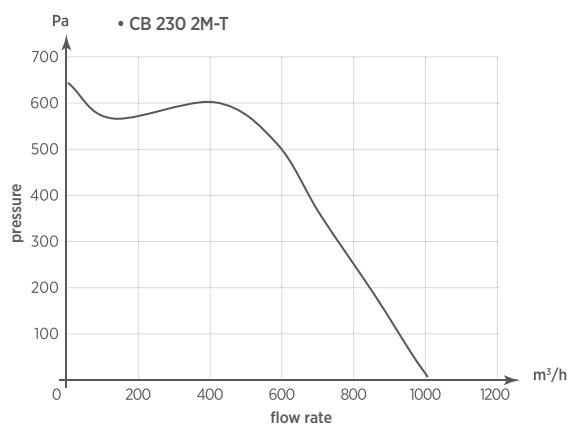
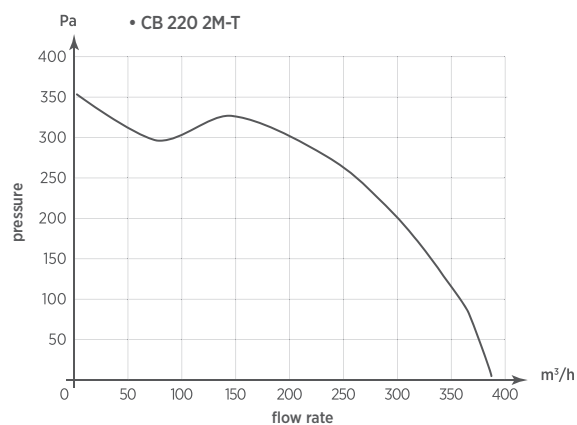
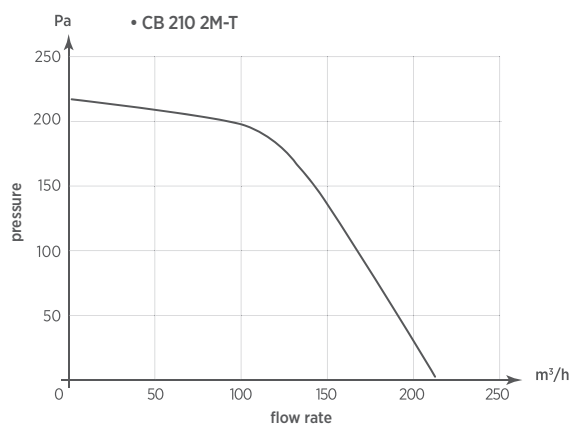

ACCESSORIES:
SEE PAGE 85



Controllers

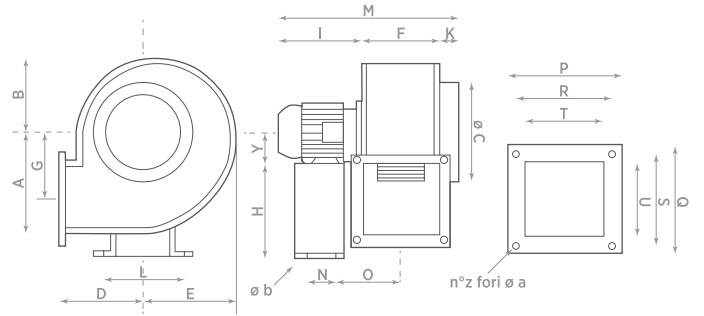

Model	A	B	ØC	D	E	F	G	H	Y	K	I	L	M	N	O	P	Q	R	S	T	U	z	Øa	Øb
CS 310	139	108	180	127	122	94	91	-	63	42	190	-	326	-	-	135	135	114	114	88	90	4	8.2	-
CS 320	172	128	200	146	150	112	117	-	63	45	190	-	347	-	-	152	152	126	126	105	105	4	8.2	-
CS 330	209	163	250	147	188	141	139	-	71	40	210	-	391	-	-	191	191	165	165	134	134	4	8.2	-
CS 340	250	194	250	178	222	164	162	-	80	45	240	-	449	-	-	225	235	195	205	161	170	4	8.2	-
CS 350	290	225	315	210	260	194	192	245	80	50	240	232	484	120	149	255	255	225	225	191	194	4	8.2	11
CS 360	290	225	315	210	260	194	192	245	90	50	255	232	499	120	155	255	255	225	225	191	194	4	8.2	11
CS 370	334	244	355	230	250	221	2109	350	100	50	315	325	586	170	173	284	305	254	275	313	244	4	10.2	11
CS 380	429	315	400	300	370	249	280	350	112	62	330	325	641	170	194	310	360	280	330	241	295	8	9	11

CS CENTRIFUGAL FAN



Centrifugal silenced duct fans to extract large air volumes and non dusty fumes.

- Suitable for application on machines where a forced ventilation or air suction is required;
- Max temperature of extracted air: 50°C;
- Low sound level and high performances;
- Steel plated frame protected by an epoxy-based anticorrosive paint and aluminium centrifugal impeller statically and dynamically balanced;
- Ball bearing class F insulation motor IP55 protected;

- Standard product supplied with impeller housing position CCW 270, different positions available on request, (see table on page 93);
- Motor speed can be regulated through industrial controllers (see accessories);
- In accordance with the essential requirements of 2006/42/EC Directive concerning machines and European Standards UNI EN ISO 13857; UNI EN ISO 12499; CEI EN 60204-1;
- Models CS 350, 360, 370 and 380: mounted on rigid base support to make installation easier.

POSITIONING

- Wall mounting

ENVIRONMENTS APPLICATION

Suitable for installation in Commercial, industrial and tertiary environment:

- Kitchen and Canteens;
- Shops;
- Offices;
- Workshops;
- Sports facilities;
- Supermarkets and Shopping Centers;
- Warehouses;
- Factories;
- Machinery.

TECHNICAL DATA

Model	Code	Motor	N° poles	Rev. per min. (RPM)	Voltage (Volt)	Frequency (Hz)	Flow rate (m³/h)	Max press. (mm H ₂ O)	Max press. Pa	Power (W)	Nom. curr. (A) 230 V	400 V	Protection degree	Noisiness dB(A) _{2m}	Weight (Kg)
CS 310 4M	0042000	single phase	4	1400	230	50	500	16	155	110	0,72	-	IP55	64	8
CS 320 4M	0042200	single phase	4	1400	230	50	800	20	200	130	0,78	-	IP55	67	9
CS 310 4T	0042100	three phase	4	1400	230/400	50	500	16	155	110	0,7	0,4	IP55	64	8
CS 320 4T	0042300	three phase	4	1400	230/400	50	800	20	200	130	0,74	0,43	IP55	67	9
CS 330 4T	0042400	three phase	4	1400	230/400	50	1500	36	360	300	1,2	0,7	IP55	70	11
CS 340 4T	0042500	three phase	4	1400	230/400	50	2900	46	450	800	2,8	1,6	IP55	73	21
CS 350 4T	0042600	three phase	4	1400	230/400	50	4100	44	430	1300	4,0	2,3	IP55	76	24
CS 360 4T	0042700	three phase	4	1400	230/400	50	5200	64	630	1800	6,0	3,5	IP55	80	27
CS 370 4T	0042800	three phase	4	1400	230/400	50	6000	66	650	2600	8,7	5,0	IP55	84	42
CS 380 4T	0042900	three phase	4	1430	230/400	50	9500	97	950	4500	15	9,0	IP55	88	63

FLOW CHARTS

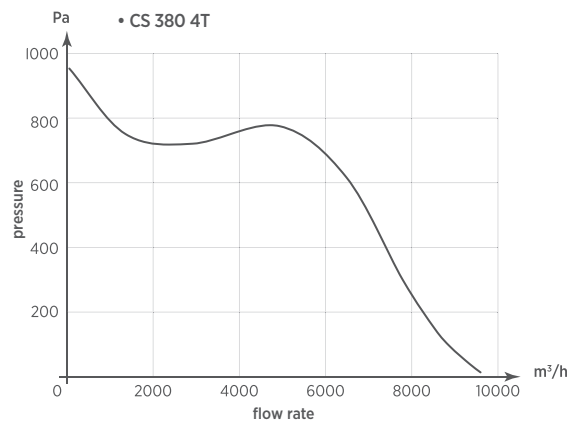
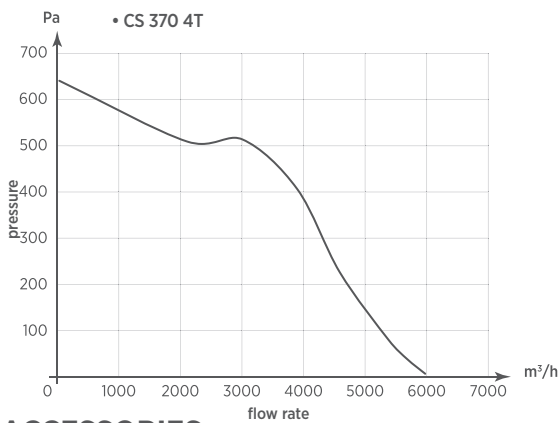
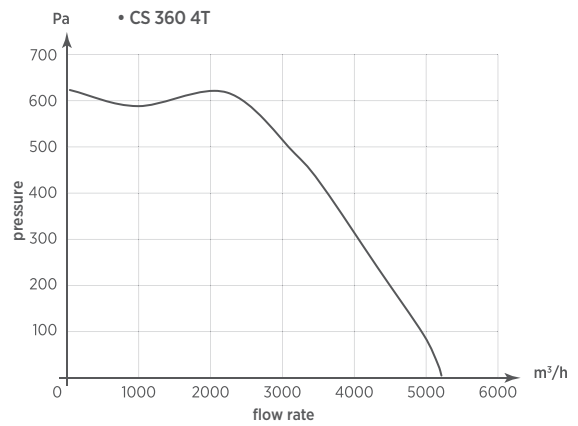
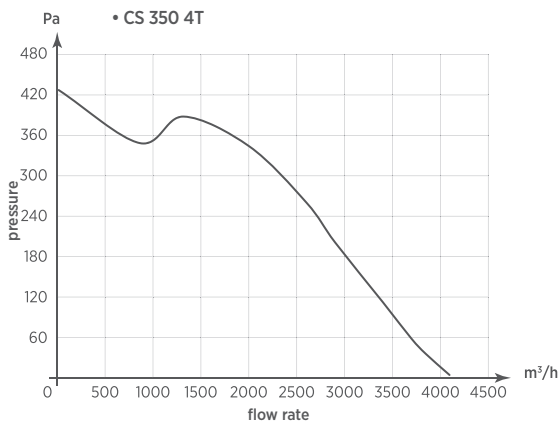
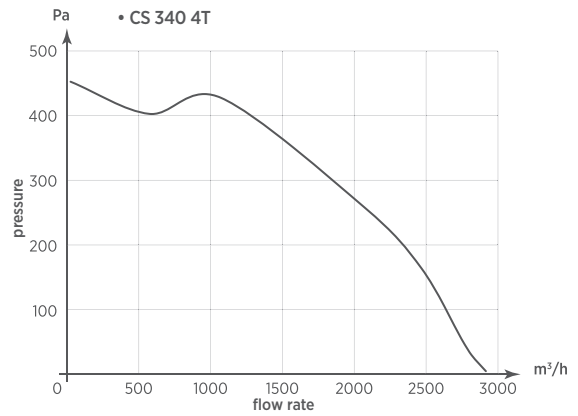
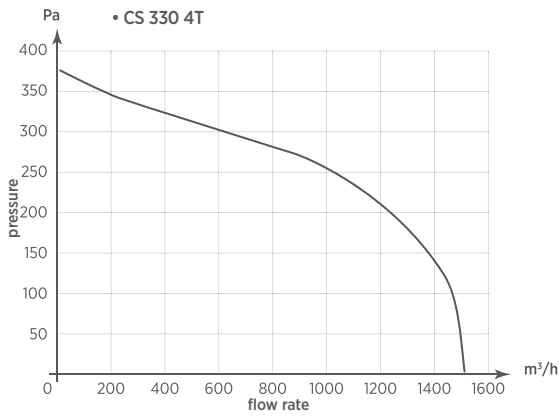
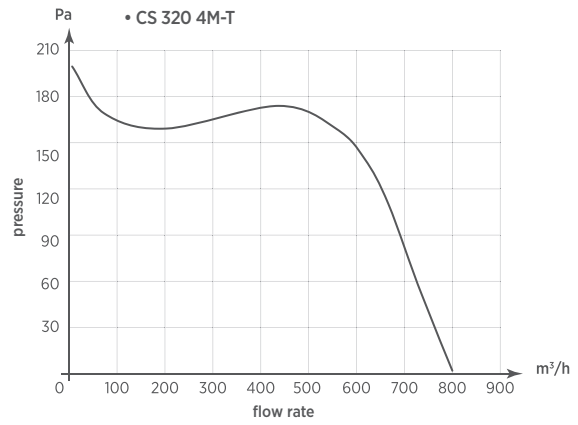
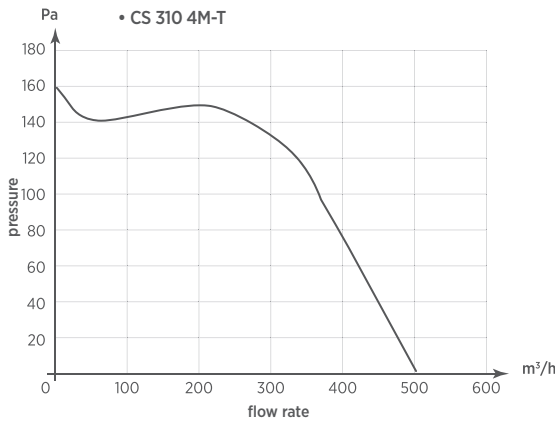

ACCESSORIES:
SEE PAGE 85



Controllers

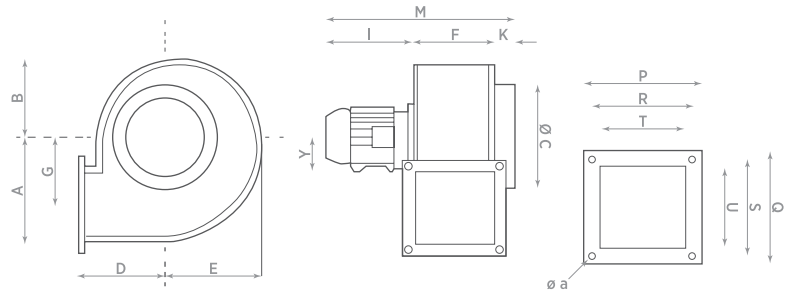

Model	A	B	ØC	D	E	F	G	Y	K	I	M	P	Q	R	S	T	U	Øa
CAI 510	80	66	68	86	72	60	50	-	-	110	170	100	100	85	85	58	58	5,7
CAI 520	95	76	90	105	80	77	60	-	-	121	198	115	110	95	90	71	64	6,8
CAI 530	139	108	180	127	122	94	91	63	42	190	326	135	135	114	114	88	90	8,2
CAI 540	172	128	200	146	150	112	117	71	45	210	367	152	152	126	126	105	105	8,2

CAI CENTRIFUGAL FAN



Centrifugal duct fans to extract air and fumes with chemical agents or for salt environments.

- Suitable for application on machines where a forced ventilation or air suction is required;
- Particularly suitable for applications where a high degree of hygiene (food industries) is necessary;
- Max temperature of extracted air: 50°C;
- Body and impeller in AISI 304 stainless steel;

- Suitable to overcome high pressure losses due to ducts resistance;
- Standard product supplied with impeller housing position CCW 270, different positions available on request, (see table on page 89);
- Motor speed can be regulated through industrial controllers (see accessories);
- Models CAI 530 and CAI 540 supplied with ball bearing motor, IP55 protected;
- In accordance with the essential requirements of 2006/42/EC Directive concerning machines and European Standards UNI EN ISO 13857; UNI EN ISO 12499; CEI EN 60204-1.

POSITIONING

- Wall mounting

ENVIRONMENTS APPLICATION

TECHNICAL DATA

Model	Code	Motor	N° poles	Rev. per min. (RPM)	Voltage (Volt)	Frequency (Hz)	Flow rate (m³/h)	Max press. (mm H ₂ O)	Max press. (Pa)	Power (W)	Nom. curr. (A) 230 V	400 V	IP Motor protection	Noisiness dB(A) _{2m}	Weight (Kg)
CAI 510 2M	0048000	single phase	2	2800	230	50	210	22	216	67	0,29	-	IP22	64	2,5
CAI 520 2M	0048200	single phase	2	2500	230	50	380	35	343	115	0,49	-	IP22	68	3,5
CAI 530 2M	0048400	single phase	2	2800	230	50	1000	66	650	400	1,8	-	IP55	76	7,0
CAI 540 2M	0048600	single phase	2	2750	230	50	1450	87	850	900	3,5	-	IP55	83	9,0
CAI 510 2T	0048100	three phase	2	2800	230/400	50	210	22	216	67	0,26	0,15	IP22	64	2,5
CAI 520 2T	0048300	three phase	2	2500	230/400	50	380	35	343	110	0,36	0,21	IP22	68	3,5
CAI 530 2T	0048500	three phase	2	2800	230/400	50	1000	66	650	400	1,75	1,0	IP55	76	7,0
CAI 540 2T	0048700	three phase	2	2750	230/400	50	1450	87	850	900	2,4	1,4	IP55	83	9,0

FLOW CHARTS

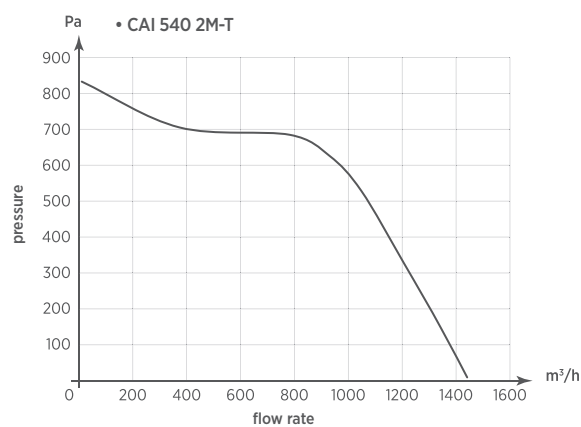
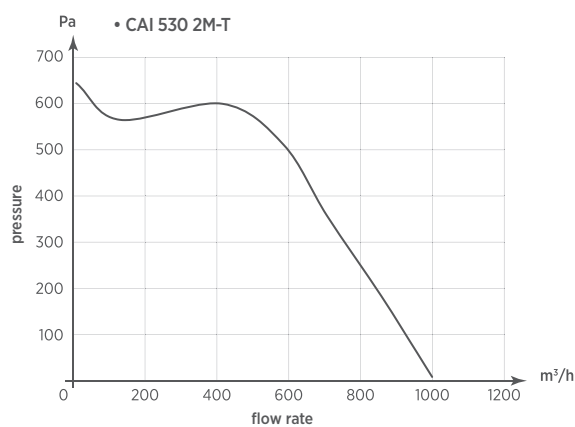
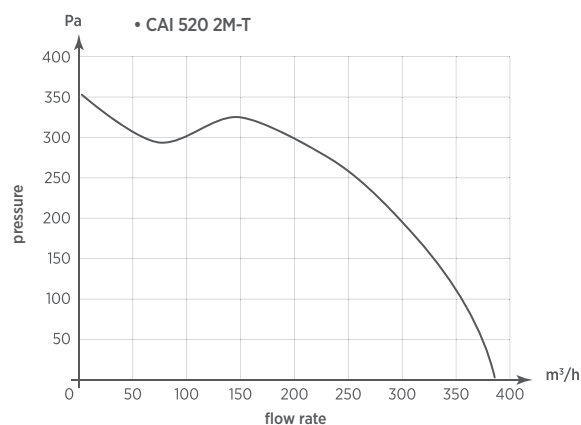
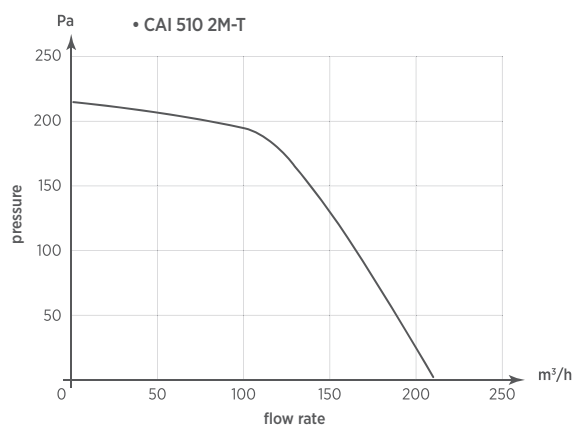

ACCESSORIES:

SEE PAGE 85



Controllers

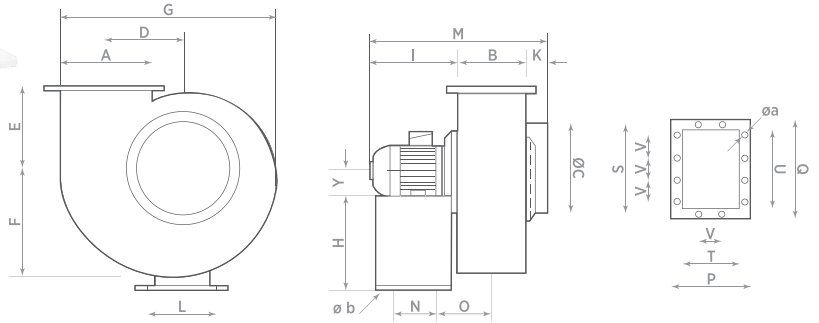

Model	A	B	ØC	D	E	F	G	H	Y	K	I	L	M	N	O	P	Q	R	S	T	U	V	Øa	Øb	n°holes
CAA 610	90	90	125	103	109	133	270	130	55	28	179	175	297	130	80	135	135	110	110	85	85	-	7,5	10	4
CAA 620	165	135	200	148	148	201	397	200	63	48	220	215	403	170	95	180	210	164	194	130	160	85	7	10	6+2
CAA 630	205	165	250	185	180	240	503	250	80	45	245	255	455	175	125	228	266	200	240	160	200	80	7	10	8+2
CAA 640	245	205	315	222	218	293	590	310	90	65	282	234	552	175	155	265	306	241	282	195	240	100	9	12	6+4
CAA 650	290	235	355	259	268	356	699	320	100	60	315	285	610	200	170	305	356	275	326	225	280	100	9	12	8+4

CAA CENTRIFUGAL FAN



Centrifugal duct fans to extract air and fumes with chemical and corrosive agents (sulphuric and nitric acid; trichloroethylene, petrol, etc.).

- Suitable for application on machines where a forced ventilation or air suction is required;
- Frame and impeller in polypropylene with nylon hub graphite treated;
- Max temperature of extracted air: 50°C;
- Ball bearing class F insulation motor IP55 protected;

- Standard product supplied with impeller housing position CCW 360, different positions available on request, (see table on page 89), model 610 not available in CW position;
- Motor speed can be regulated through industrial controllers (see accessories);
- In accordance with the essential requirements of 2006/42/EC Directive concerning machines and European Standards UNI EN ISO 13857; UNI EN ISO 12499; CEI EN 60204-1.

POSITIONING

- Wall mounting

ENVIRONMENT APPLICATION

Suitable for installation in tertiary and industrial environments with high presence of fumes with chemical and corrosive agents:

- Warehouses;
- Factories;
- Machinery.

TECHNICAL DATA

Model	Code	Motor	N° poles	Rev. per min. (RPM)	Voltage (Volt)	Frequency (Hz)	Flow rate (m³/h)	Max press. (mm H ₂ O)	Max press. (Pa)	Power (W)	Nom. curr. (A) 230 V 400 V	IP Motor protection	Noisiness dB(A) _{2m}	Weight (Kg)
CAA 610 2T	0044000	Three phase	2	2800	230/400	50-60	550	49	481	220	0,83 0,48	IP55	65	6,0
CAA 620 2T	0044100	Three phase	2	2800	230/400	50-60	2000	103	103	1010	3,45 2	IP55	68	13,0
CAA 620 4T	0044200	Three phase	4	1400	230/400	50-60	1200	26	255	270	1,18 0,68	IP55	55	13,0
CAA 630 4T	0044300	Three phase	4	1400	230/400	50-60	3000	43	422	800	2,6 1,5	IP55	64	19,0
CAA 640 4T	0044400	Three phase	4	1400	230/400	50-60	4300	61	598	1300	4,3 2,5	IP55	65	31,0
CAA 650 4T	0044500	Three phase	4	1400	230/400	50-60	6500	90	883	2300	10,4 6	IP55	70	64,0

FLOW CHARTS

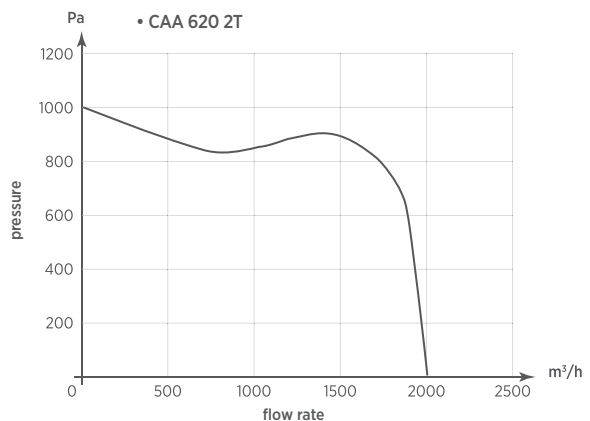
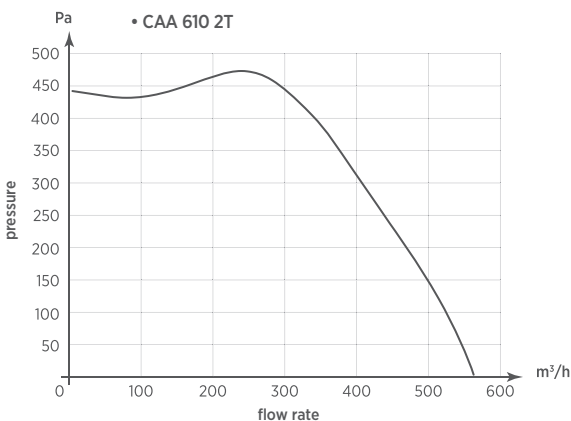

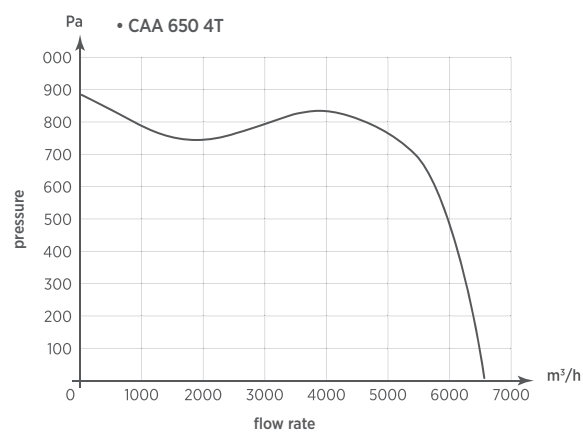
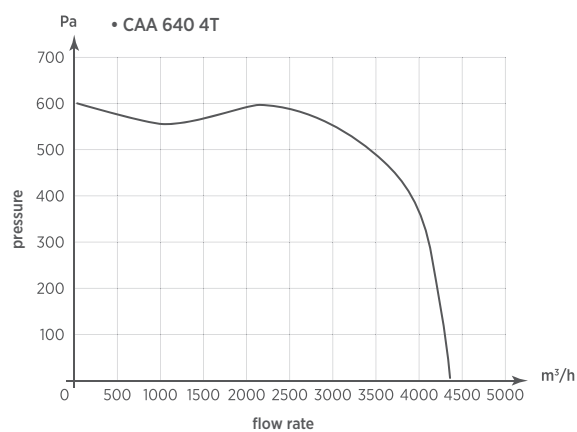
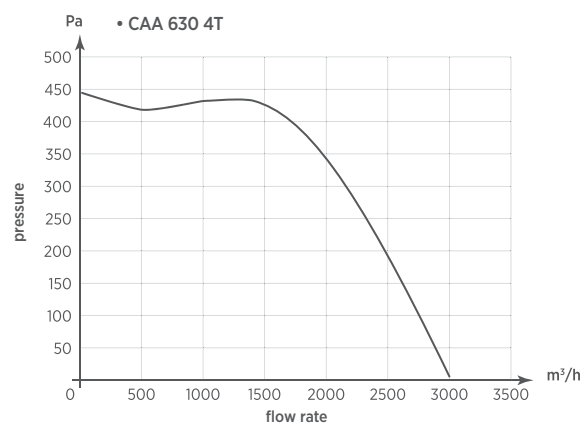
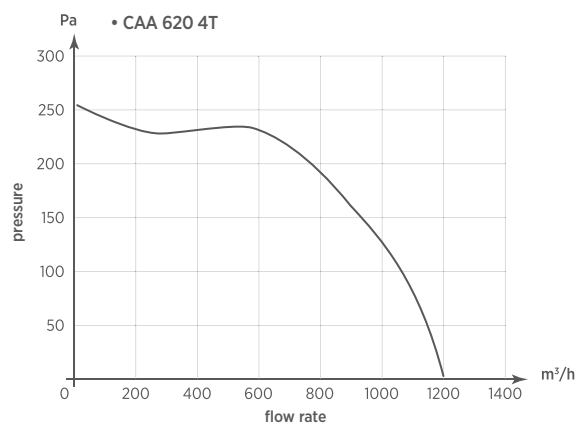

ACCESSORIES:

SEE PAGE 85



Controllers

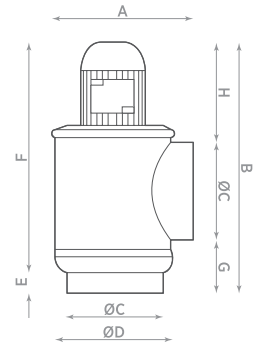

Model	A	B	ØC	ØD	E	F	G	H
AC 150	230	340	148	185	25	315	65	150

AC CENTRIFUGAL FAN



Centrifugal angle duct fans to extract air and non dusty fumes.

- Suitable for application on machines where a forced ventilation or air suction is required;
- Steel plated frame protected by an epoxy-based anticorrosive paint and zinc plated steel impeller;
- Ball bearing motor;

- External motor allows to extract air with temperature up to 70°C;
- Motor speed can be regulated through industrial controllers (see accessories);
- In accordance with the essential requirements of 2006/42/EC Directive concerning machines and European Standards UNI EN ISO 13857; UNI EN ISO 12499; CEI EN 60204-1.

POSITIONING

- Wall mounting

ENVIRONMENTS APPLICATION

Suitable for installation in Commercial, industrial and tertiary environment:

- Kitchen and Canteens;
- Shops;
- Offices;
- Workshops;
- Sports facilities;
- Supermarkets and Shopping Centers;
- Warehouses;
- Factories;
- Machinery.

TECHNICAL DATA

Model	Code	Motor	N° poles	Rev. per min. (RPM)	Voltage (Volt)	Frequency (Hz)	Flow rate (m³/h)	Max press. (mm H ₂ O)	Max press. (Pa)	Power (W)	Nom. curr. (A)		Protection degree	Noisiness dB(A) _{1m}	Weight (Kg)
											230 V	400 V			
AC 150 2M	0044600	single phase	2	2700	230	50	400	18,3	180	110	0,5	-	IP44	62	3,5
AC 150 2T	0044700	three phase	2	2700	230/400	50	400	18,3	180	100	0,4	0,25	IP54	62	3,5
AC 200 2M*	0044800	single phase	2	2700	230	50	650	31	303	350	1,5	-	70	2700	8,0
AC 200 2T*	0044900	three-phase	2	2750	230/400	50	650	31	303	350	1,68	0,95	70	2750	6,5

(*) Models not in compliance with Reg. 327/11, only for extra UE market

FLOW CHARTS

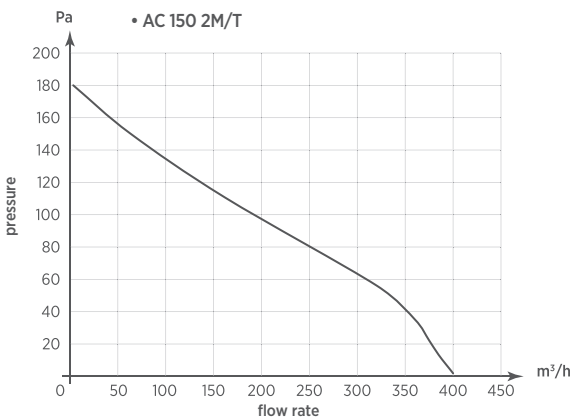

ACCESSORIES: SEE PAGE 85



Controllers

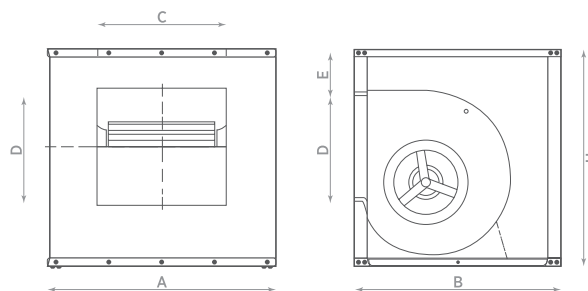
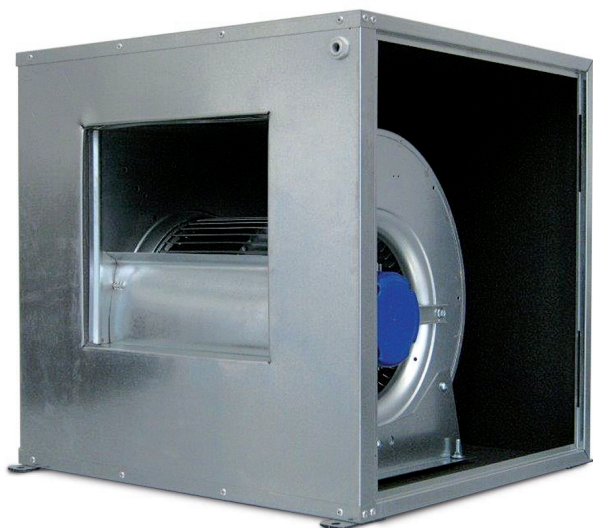

Model	VENT	Dimensions mm					
		A	H	B	Outlet CxD	E	L
CV-D	7/7	450	460	500	230x208	120	121
CV-D	9/7	500	520	550	230x263	110	118
CV-D	9/9	500	520	550	300x263	110	118
CV-D	10/8	550	575	600	260x292	120	516
CV-D	10/10	550	575	600	326x292	115	129
CV-D	12/9	650	650	700	300x345	115	152
CV-D	12/12	650	650	700	300x345	115	152
CV-D	15/15	800	755	800	473x404	110	198

CV-D

BOX FAN

Box fans directly driven with sound absorbing lining, equipped with double inlet centrifugal fan with forward curved blades. Highly suitable in ventilation systems.

- Series composed by 8 sizes, with flow rate starting from 1.230 m³/h up to 11.900 m³/h;
- Working temperature : +60°C;
- Lightweight self-supporting galvanised steel sheet lined with sound-absorbing

material of thickness 5 mm

- Equipped with power supply cable gland;
- Inspection door motor side with lock system CE compliance;
- Single phase motor 230 V or three phase 400 V, direct coupled, IP54 protected, Class F;
- Single speed as default, three speed version available on request.



POSITIONING

- Floor mounting
- Shelf mounting
- Ceiling mounting

ENVIRONMENTS APPLICATION

CV-D box fans are recommended for domestic and industrial applications where the air to be treated is clean and a noiseless and reliable machine is required for installation

- shops
- laboratories

- craft workshops
- restaurants, bars, canteens
- offices
- houses

TECHNICAL DATA

Model	Code	Motor	N° poles	Rev. per min. (RPM)	Voltage (Volt)	Frequency (Hz)	Flow rate (m ³ /h)	Max press. (mm H ₂ O)	Max press. (Pa)	Power (kW)	Nom. curr. (A)		IP Motor protection	Noisiness dB(A) _{2m}	Weight (kg)
											230 V	400 V			
CV-D 7/7 4M	0012802	Single phase	4	1230	230	50	1520	26	255	0,15	1,4	-	IP54	56	20
CV-D 7/7 6M	0012804	Single phase	6	820	230	50	1230	13	128	0,07	0,6	-	IP54	50	20
CV-D 9/7 4M	0012806	Single phase	4	1320	230	50	2600	47	461	0,37	2,9	-	IP54	63	26,8
CV-D 9/7 6M	0012808	Single phase	6	850	230	50	2200	18	177	0,25	2,3	-	IP54	60	26,8
CV-D 9/9 4M	0012810	Single phase	4	1320	230	50	2800	37	363	0,37	2,9	-	IP54	63	29
CV-D 9/9 6M	0012812	Single phase	6	850	230	50	2200	16	157	0,15	1,2	-	IP54	57	27,5
CV-D 10/8 4M	0012814	Single phase	4	1310	230	50	3600	52	510	0,55	5,7	-	IP54	67	33
CV-D 10/8 6M	0012816	Single phase	6	830	230	50	2900	25	245	0,25	2,3	-	IP54	61	33
CV-D 10/10 4M	0012818	Single phase	4	1320	230	50	2800	47	461	0,37	2,9	-	IP54	62	33
CV-D 10/10 6M	0012820	Single phase	6	830	230	50	3200	22	216	0,25	2,3	-	IP54	59	32,5
CV-D 12/9 6M	0012822	Single phase	6	900	230	50	5500	34	334	0,55	4,7	-	IP54	66	44,8
CV-D 12/12 6M	0012824	Single phase	6	850	230	50	4900	30	294	0,55	4,7	-	IP54	61	46,4
CV-D 12/9 6T	0012801	Three phase	6	850	400	50	7000	32	314	1,10	4,8	2,8	IP54	72	46,6
CV-D 12/12 6T	0012803	Three phase	6	850	400	50	7800	32	314	1,10	4,8	2,8	IP54	72	48
CV-D 15/15 6T	0012805	Three phase	6	890	400	50	11900	50	490	2,20	9,2	5,3	IP54	72	71,8

FLOW CHARTS

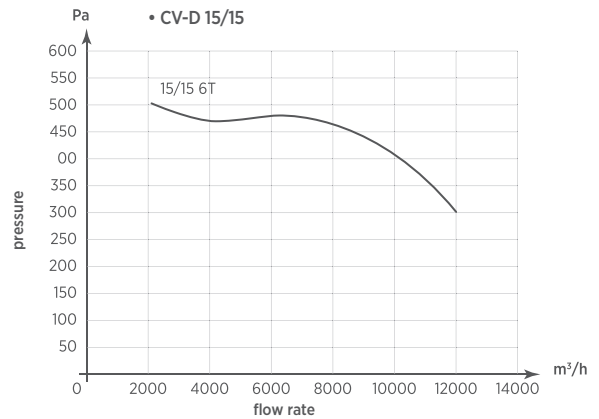
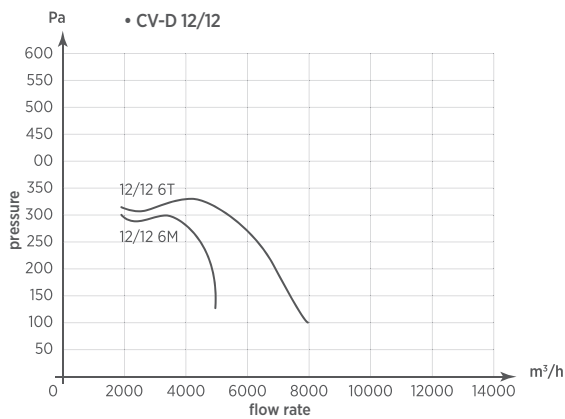
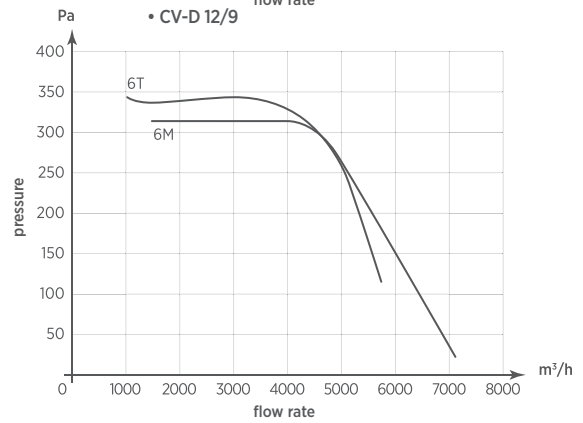
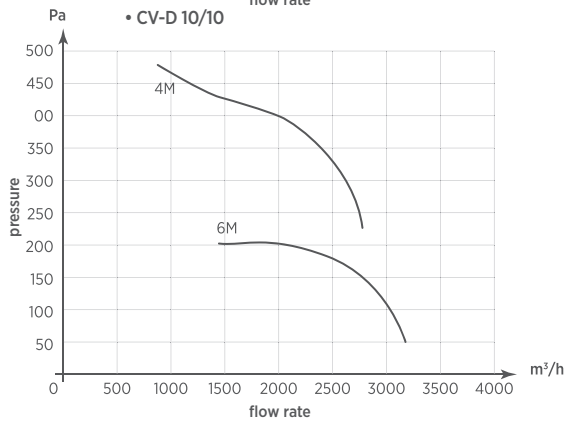
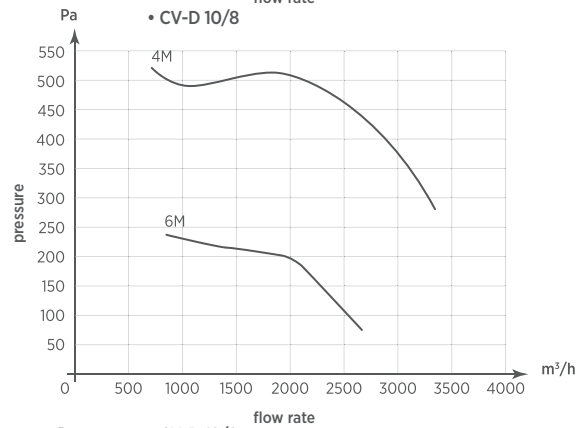
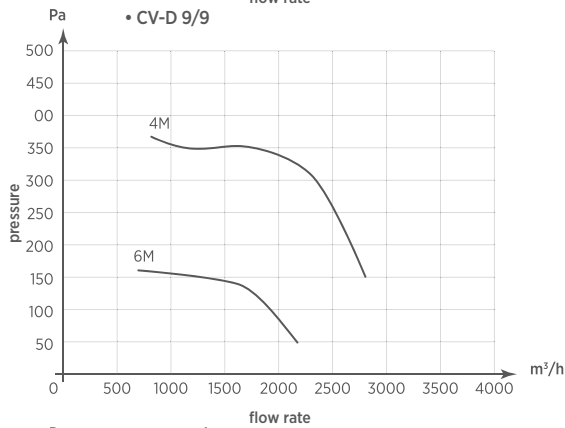
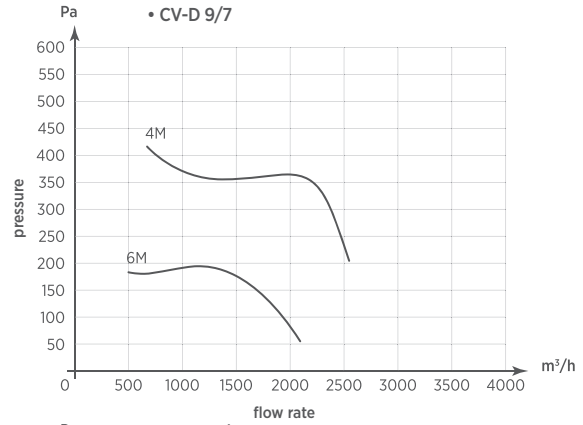
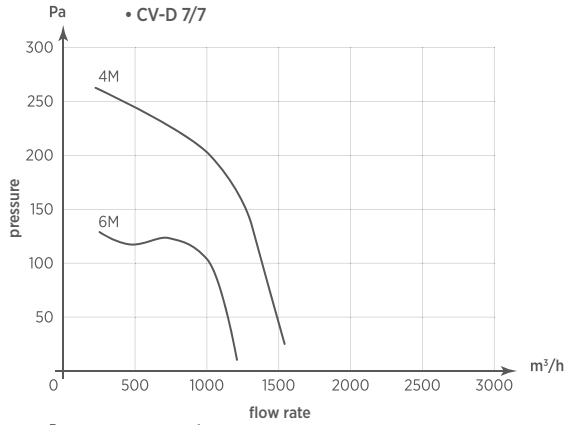

ACCESSORIES:
SEE PAGE 85



Controllers

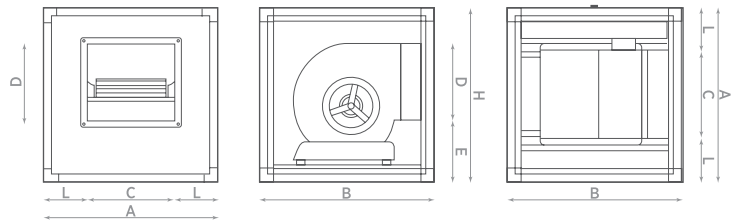

Model	VENT	Dimensions mm			Outlet CxD	E	L
		A	H	B			
CV-2P	7/7	500	500	500	232x210	188	134
CV-2P	9/7	600	600	600	232x265	195	134
CV-2P	9/9	600	600	600	302x265	195	149
CV-2P	10/8	600	600	600	262x294	120	516
CV-2P	10/10	600	600	600	328x294	225	169
CV-2P	12/9	750	750	750	302x347	250	224
CV-2P	12/12	650	650	700	389x347	250	180

CV-2P

BOX FAN

Box fans directly driven with sound absorbing lining, equipped with double inlet centrifugal fan with forward curved blades. Highly suitable in ventilation systems.

- Series composed by 8 sizes, with flow rate starting from 1.230 m³/h up to 11.900 m³/h;
- Working temperature : +60°C;
- Lightweight self-supporting galvanised steel sheet lined with sound-absorbing

material of thickness 5 mm

- Equipped with power supply cable gland;
- Inspection door motor side with lock system CE compliance;
- Single phase motor 230 V or three phase 400 V, direct coupled, IP54 protected, Class F;
- Single speed as default, three speed version available on request.



POSITIONING

- Floor mounting - Shelf mounting - Ceiling mounting

ENVIRONMENTS APPLICATION

CV-2P box fans are ideal for professional applications where an absolutely noiseless and reliable machine is required for installation

- Offices
- Schools, crèches, nursery schools
- Hospitals and surgeries
- restaurants, bars, canteens
- Houses
- shops
- laboratories
- Toilets

TECHNICAL DATA

Model	Code	Motor	N° poles	Rev. per min. (RPM)	Voltage (Volt)	Frequency (Hz)	Flow rate (m ³ /h)	Max press. (mm H ₂ O)	Max press. (Pa)	Power (kW)	Nom. curr. (A) 230 V	400 V	IP Motor protection	Noisiness dB(A) _{2m}	Weight (Kg)
CV-2P 7/7 4M	0012902	single phase	4	1230	230	50	1500	25	250	0,15	1,4	-	IP54	54	30
CV-2P 7/7 6M	0012904	single phase	6	820	230	50	1200	12,5	125	0,07	0,6	-	IP54	48	30
CV-2P 9/7 4M	0012906	single phase	4	1320	230	50	3000	42,5	425	0,37	2,9	-	IP54	57	38
CV-2P 9/7 6M	0012908	single phase	6	850	230	50	2200	19	190	0,25	2,3	-	IP54	53	38
CV-2P 9/9 4M	0012910	single phase	4	1320	230	50	3500	38	380	0,37	2,9	-	IP54	56	40
CV-2P 9/9 6M	0012912	single phase	6	860	230	50	2600	16	160	0,15	1,2	-	IP54	54	40
CV-2P 10/8 4M	0012914	single phase	4	1310	230	50	3500	55	550	0,55	5,7	-	IP54	59	67
CV-2P 10/8 6M	0012916	single phase	6	830	230	50	2900	29	290	0,25	2,3	-	IP54	55	67
CV-2P 10/10 4M	0012918	single phase	4	1310	230	50	3300	50	500	0,55	5,7	-	IP54	61	50
CV-2P 10/10 6M	0012920	single phase	6	830	230	50	3000	22	220	0,25	2,3	-	IP54	55	50
CV-2P 12/9 6M	0012922	single phase	6	900	230	50	4700	36	360	0,55	4,7	-	IP54	63	63
CV-2P 12/12 6M	0012924	single phase	6	850	230	50	6000	33	330	0,75	2,0	-	IP54	61	62
CV-2P 12/9 6T	0012901	three phase	6	850	400	50	7000	40	400	1,10	4,8	2,8	IP54	65	63
CV-2P 12/12 6T	0012903	three phase	6	890	400	50	8000	35	350	1,10	4,8	2,8	IP54	65	62

FLOW CHARTS:

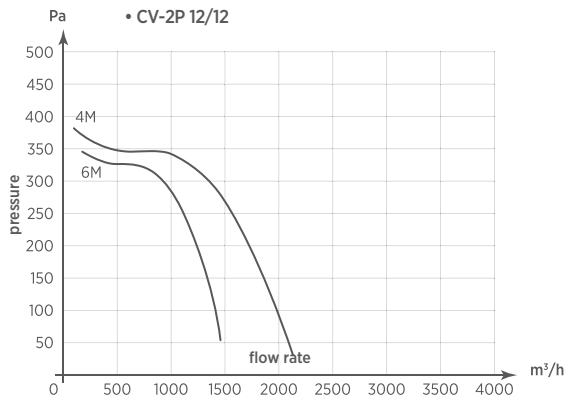
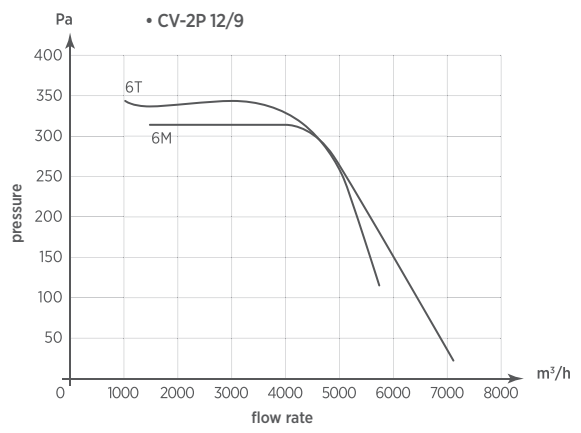
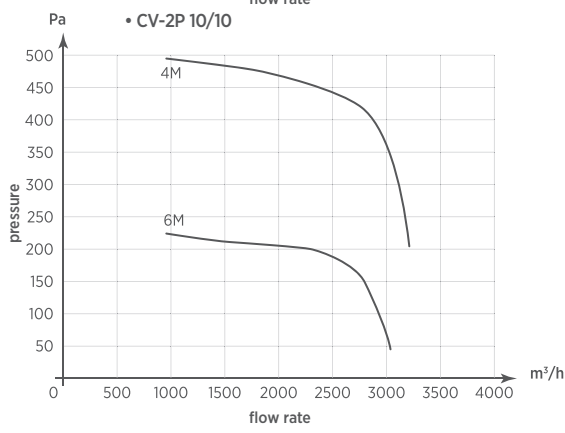
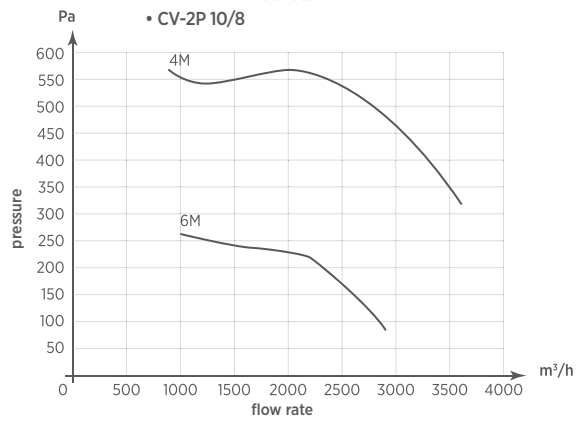
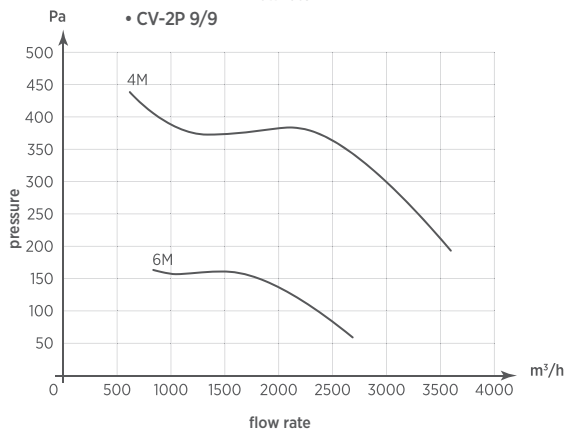
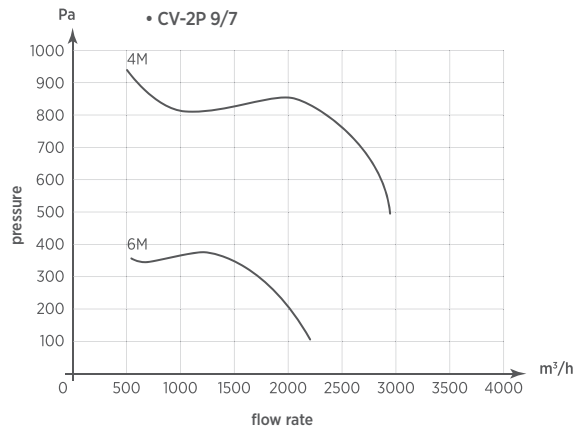
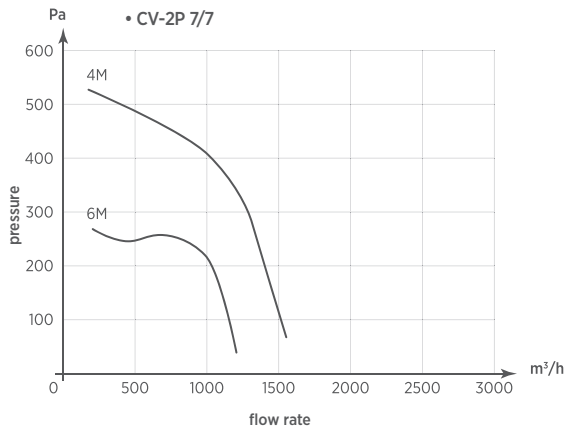

ACCESSORIES ON DEMAND:

Anti-vibration flanged joint

Outlet connection with protection grille

Carrying filters connection

Rubber feet

Rain cover

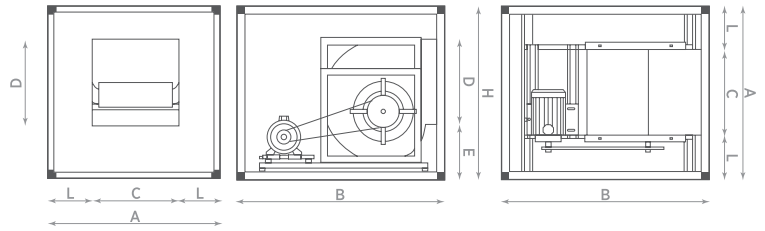

Model	VENT	A	H	B	Outlet CxD	E	L
CV-T	7/7	600	600	600	232x210	198	184
CV-T	9/7	600	600	750	302x265	205	149
CV-T	10/10	750	750	900	302x265	195	149
CV-T	12/12	750	750	900	262x294	120	516
CV-T	15/15	900	900	1000	475x406	285	212
CV-T	18/18	1000	1000	1200	542x484	353	229

CV-T BOX FAN



Box belt driven fans with frame in aluminium paneling and acoustic cladding equipped with double inlet fan with forward curved blades. Designed for use in professional ventilation systems, where low noise and thermal insulation are required.

- Series composed by 6 sizes, with flowrate starting from 800 m³/h up to 16.000 m³/h and pressure from 100 up to 800 Pa;
- Working temperature : +60°C;
- Cladding panels made in sheet steel, external RAL 7032 painted and

galvanised internal, interposed with 25 mm of high density polyurethane foam, having a sound reduction of $R_w = 40$ dB and thermal conductivity of 0,0247 W (m °K);

- Inspection door with lock system CE compliance, complete with handle
- UNEL-MEC asynchronous three-phase motor 400V, class F insulation, IP55 protected;
- Single speed as default, three speed version available on request.

POSITIONING

- Floor mounting
- Shelf mounting
- Ceiling mounting

ENVIRONMENT APPLICATION

CV-T box fans are ideal for professional, high performance applications where an absolutely noiseless, efficient and reliable machine is required for installation

- Hospitals, clinics,
- Shopping centers
- Offices

- Universities, school buildings
- Canteens, restaurants
- Hotels, residences, housing estates

TECHNICAL DATA

Model	Flow rate m ³ /h	Pa 100 RPM-kW	Pa 200 RPM-kW	Pa 300 RPM-kW	Pa 400 RPM-kW	Pa 500 RPM-kW	Pa 600 RPM-kW	Pa 700 RPM-kW	Pa 800 RPM-kW	dB[A] min/max
CV-T 7/7	800	900-0,25	1260-0,25	-	-	-	-	-	-	50/53
	1000	955-0,25	1260-0,25	-	-	-	-	-	-	51/55
	1500	1068-0,25	1326-0,37	1555-0,55	1767-0,55	1958-0,75	-	-	-	57/65
	2000	-	1420-0,55	1672-0,55	1848-0,75	2068-0,75	-	-	-	63/69
CV-T 9/9	1500	700-0,25	1008-0,25	1260-0,55	-	-	-	-	-	51/60
	2000	714-0,25	1000-0,37	1250-0,55	1420-0,55	1566-0,75	1754-0,75	1958-1,1	-	54/70
	3000	-	1083-0,55	1278-0,55	1410-0,75	1566-1,1	1754-1,1	1848-1,5	2068-1,5	65/72
CV-T 10/10	2000	630-0,37	840-0,37	1068-0,55	1206-0,55	1410-0,75	1488-0,75	-	-	-
	3000	741-0,55	913-0,55	1083-0,55	1197-0,75	1336-1,1	1410-1,1	1568-1,5	1754-1,5	60/71
	4000	-	1015-0,75	1133-1,1	1269-1,1	1410-1,5	1494-1,5	1590-2,2	1679-2,2	70/75
CV-T 12/12	3000	504-0,37	741-0,55	913-0,55	-	-	-	-	-	50/60
	4000	562-0,55	710-0,55	906-0,75	1015-1,1	1195-1,5	-	-	-	57/68
	5000	571-0,55	746-0,75	906-1,1	1007-1,5	1128-1,5	1277-2,2	1353-2,2	1400-3	60/72
	6000	634-0,75	746-1,1	881-1,5	1007-1,5	1140-2,2	1277-2,2	1326-3	1400-3	65/75
	7000	705-1,1	793-1,5	939-2,2	1064-2,2	1125-3	1260-3	1326-3	-	68/75
	8000	-	840-2,2	939-2,2	1068-3	1189-3	1250-4	-	-	72/75
CV-T 15/15	6000	456-0,55	634-0,75	746-1,1	846-1,5	939-2,2	1064-2,2	1189-3	-	55/70
	7000	453-0,75	634-1,1	746-1,5	840-2,2	939-2,2	1068-3	1125-3	-	58/70
	8000	508-1,1	634-1,5	712-2,2	840-2,2	955-3	1068-3	1120-4	-	60/72
	9000	508-1,5	634-1,5	712-2,2	840-3	955-3	1081-4	1120-4	-	65/75
	10000	567-1,5	638-2,2	798-2,2	840-3	933-4	1061-4	1120-5,5	-	67/75
	12000	630-3	741-3	840-4	875-4	880-5,5	1045-5,5	-	-	72/75
CV-T 18/18	8000	360-0,55	508-1,1	634-1,5	712-2,2	840-2,2	-	-	-	58/69
	10000	403-1,1	508-1,5	638-2,2	712-2,2	840-3	875-4	1000-4	-	62/74
	12000	453-1,5	570-2,2	638-2,2	741-3	787-4	875-4	980-5,5	-	67/75
	14000	507-2,2	570-2,2	663-3	741-4	787-4	871-5,5	980-5,5	-	70/75
	16000	504-3	630-3	663-4	737-5,5	824-5,5	875-7,5	937-7,5	-	73/75

ACCESSORIES ON DEMAND:

Anti-vibration
flanged joint

Outlet
connection with
protection grille

Carrying filters
connection

Rubber feet

Rain cover

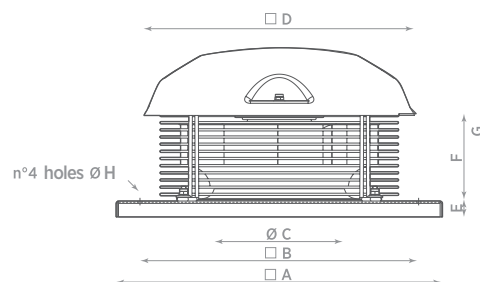

Modello	A×A	B×B	ØC	D×D	E	F	G	ØH
TXC 301	310	260	140	340	212,5	107,5	20	5,5
TXC 302	310	260	140	340	212,5	107,5	20	5,5
TXC401	410	350	161	340	212,5	107,5	20	5,5
TXC 402	410	350	161	340	212,5	107,5	20	5,5

TXC

ROOF FAN

The most compact. Ideal for small/medium sized structures.

- Centrifugal roof fan to extract air or fumes directly outside or through ducting;
- Suitable for domestic and industrial applications, such as block of flats, houses, offices, restaurants, gyms, swimming-pools;
- Motor impeller with external rotor, statically and dynamically balanced equipped with a ball bearing class B insulation motor, IP44 protected;
- IPX5 protected;
- Max temperature of extracted air: 70°C (model TXC 402 max. temp. 60°C);
- Fast and easy installation;



- Suitable to be installed on standard chimney flues 30x30 cm or 40x40 cm;
- Low energy consumption and reduced sound level;
- Zinc plated steel frame complete with plastic cover;
- Safety protection outside grille;
- Self-cleaning backward curved blade impeller;
- Adjustable speed through RGM2 or RGE controller (see accessories);
- In accordance with the essential requirements of the current European Directives and with European Standard EN 60335-2-80.

POSITIONING

- Roof fan

ENVIRONMENT APPLICATION

Suitable for installation in Commercial, industrial and tertiary environment:

- Apartments building;
- Villas;
- Offices
- Restaurants;
- Shops;
- Gyms;
- Swimmipools;
- Factories;
- Machinery.

TECHNICAL DATA

Model	Code	Motor	N° poles	Rev. per min. (RPM)	Voltage (Volt)	Frequency (Hz)	Flow rate (m ³ /h)	Max press. (mm H ₂ O)	Max press. (Pa)	Power (W)	Nom. curr. (A)	IP Motor protection	Noisiness dB(A) _{1m}	Weight (Kg)
TXC 301	0040600	single phase	2	2400	230	50-60	500	31	302	50	0,25	IP44	52	4,6
TXC 302	0040700	single phase	2	2600	230	50-60	780	39	383	65	0,33	IP44	53	4,6
TXC 401	0040800	single phase	2	2600	230	50-60	1000	39	383	65	0,33	IP44	52	5,5
TXC 402	0040900	single phase	2	2600	230	50-60	1550	66	650	145	0,7	IP44	57	6,3

FLOW RATE

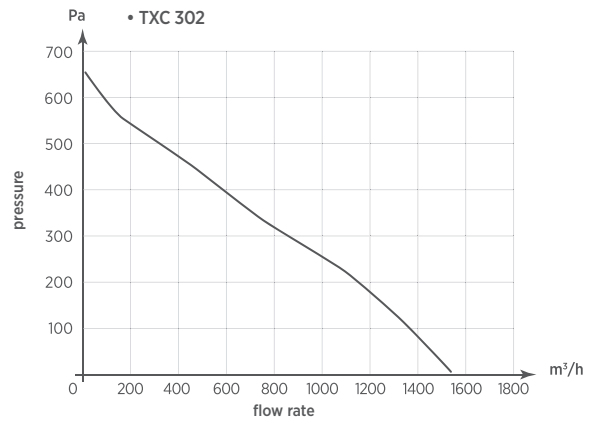
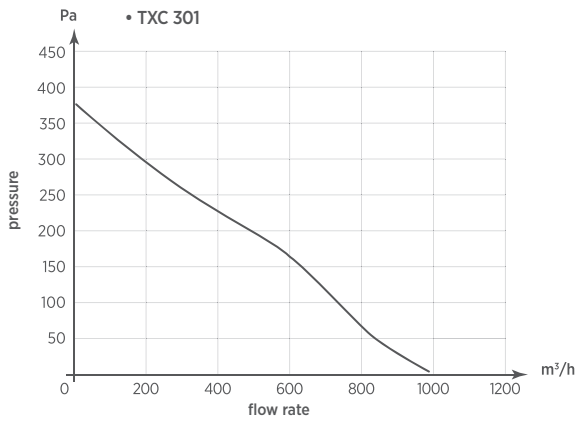
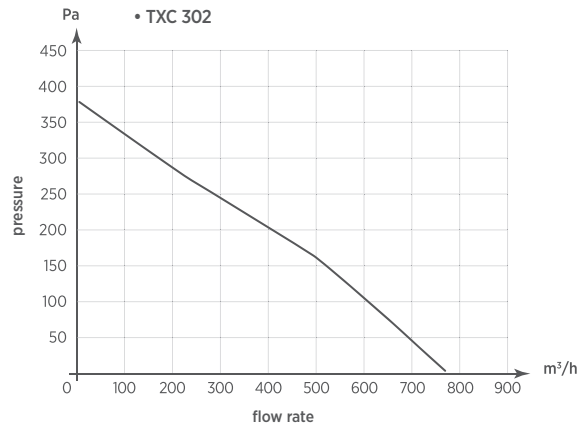
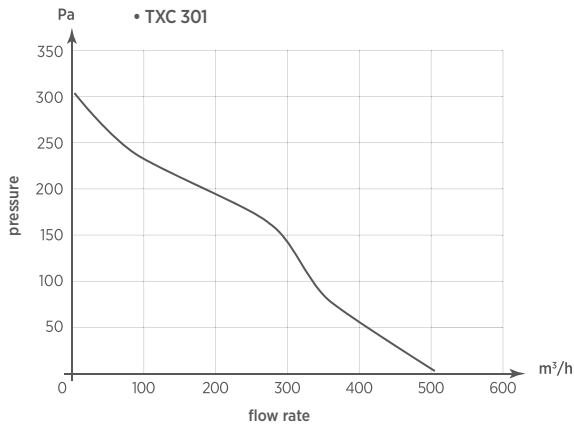

ACCESSORIES: SEE PAGE 85



Controllers

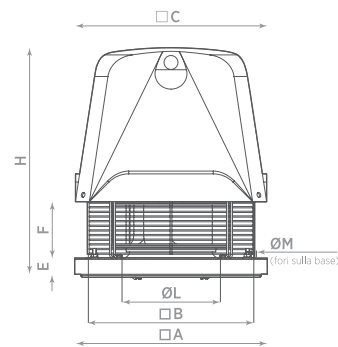
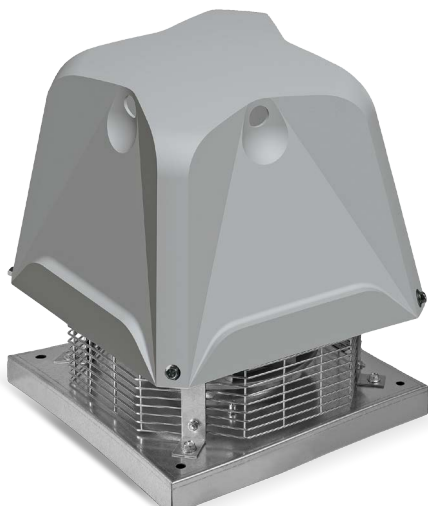

Model	A×A	B×B	C×C	E	F	H	ØL	ØM
TXP 3	400	350	412	40	135	493	200	11,2
TXP 6	400	350	412	40	135	493	250	11,2
TXP 7	560	460	560	40	240	608	350	11,2
TXP 8	560	460	560	40	240	608	350	11,2
TXP 10	710	610	740	40	253	638	400	11,2
TXP 12	900	800	950	40	305	910	500	11,2
TXP 14	900	800	950	45	300	910	550	11,2
TXP 15	900	800	950	45	300	910	600	11,2
TXP 18	900	800	950	45	300	910	600	11,2

TXP

ROOF FAN

The most powerful. Ideal for medium/large sized structures.

- Centrifugal roof fans with horizontal outlet to extract air or fumes directly outside or through ducts;
- Medium-high flow rates to overcome pressure losses due to duct resistance;
- Ball bearing class F insulation motor IP55 protected;
- Zinc-plated steel frame and impeller, cover made of plastic material;
- Safety protection outside grille;

- Self-cleaning backward curved blade impeller, statically and dynamically balanced;
- Some models can be regulated through RGM or RGT controllers (see accessories);
- Max temperature of extracted air: 60°C;
- In accordance with the essential requirements of 2006/42/EC Directive concerning machines and European Standards UNI EN ISO 13857; UNI EN ISO 12499; CEI EN 60204-1.



POSITIONING

- Roof mounting

ENVIRONMENT APPLICATION

Suitable for both Industrial and civil application, such as canteens, restaurants, sports facilities, supermarkets and shopping centers, factories, warehouse, offices, toilets and apartment buildings

TECHNICAL DATA

Model	Code	Motor	N° poles	Rev. per min. (RPM)	Voltage (Volt)	Frequency (Hz)	Flow rate (m³/h)	Max press. (mm H ₂ O)	Max press. (Pa)	Power (W)	Nom. Curr. (A)		IP Motor protection	Noisiness (RPM)	Weight (kg)
											230 V	400 V			
TXP 3M	0074100	Monofase	4	1400	230	50-60	1200	20	196	120	0,81	-	IP55	60	14
TXP 6M	0074200	Monofase	4	1400	230	50-60	1800	30	294	180	1,05	-	IP55	66	18
TXP 7M	0074300	Monofase	4	1400	230	50-60	3100	40	392	250	1,40	-	IP55	69	25
TXP 8M	0074400	Monofase	4	1400	230	50-60	4200	45	441	370	1,90	-	IP55	70	30
TXP 10M	0074500	Monofase	4	1400	230	50-60	5700	56	549	750	3,40	-	IP55	75	40
TXP 3T	0074600	Monofase	4	1400	230/400	50-60	1200	20	196	120	0,81	0,47	IP55	60	14
TXP 6T	0074700	Monofase	4	1400	230/400	50-60	1800	30	294	180	1,05	0,60	IP55	66	18
TXP 7T	0074800	Monofase	4	1400	230/400	50-60	3100	40	392	250	1,42	0,82	IP55	69	25
TXP 8T	0074900	Monofase	4	1400	230/400	50-60	4200	45	441	370	1,90	1,10	IP55	70	30
TXP 10T	0075000	Monofase	4	1400	230/400	50-60	5700	56	549	750	3,4	1,8	IP55	75	40
TXP 12T	0075100	Monofase	6	900	230/400	50-60	7100	39	382	750	3,81	2,20	IP55	71	57
TXP 14T	0075200	Monofase	6	900	230/400	50-60	10800	48	471	1100	5,37	3,10	IP55	75	76
TXP 15T	0075400	Monofase	6	900	230/400	50-60	14200	57	559	2200	9,35	5,40	IP55	80	96
TXP 18T	0075500	Monofase	6	900	230/400	50-60	18800	65	637	3000	11,95	6,90	IP55	84	110

FLOW CHARTS

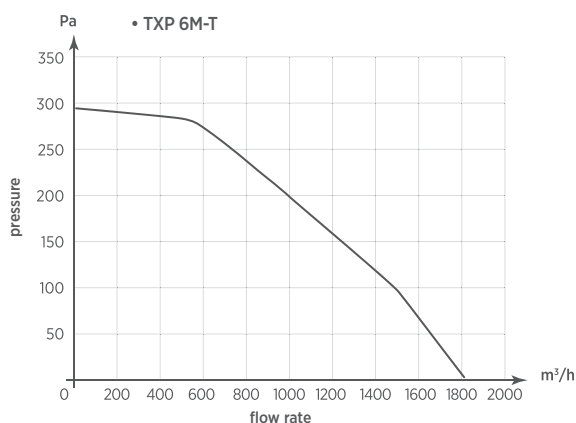
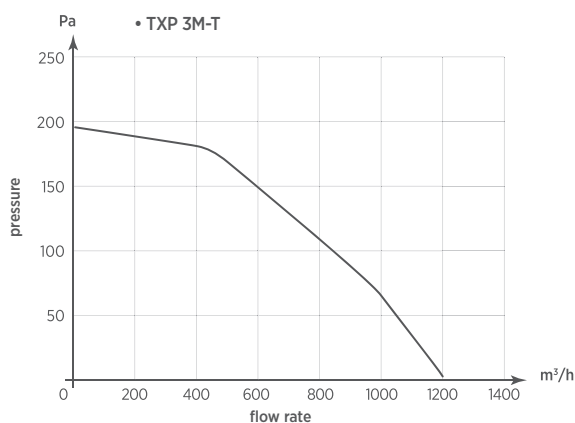

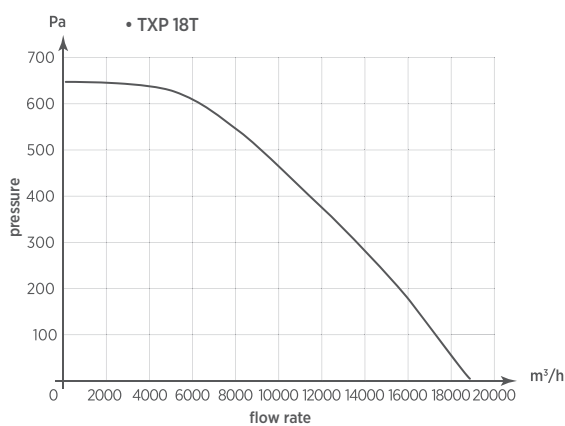
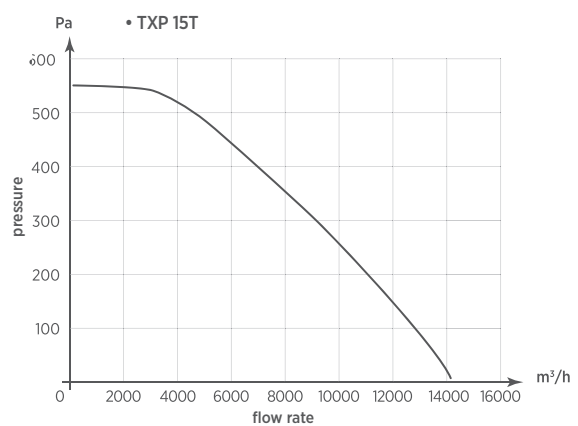
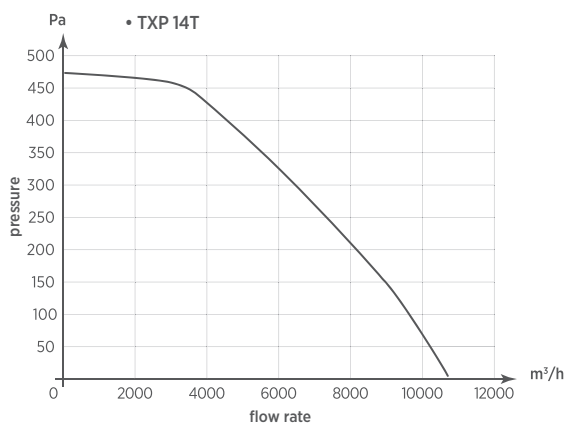
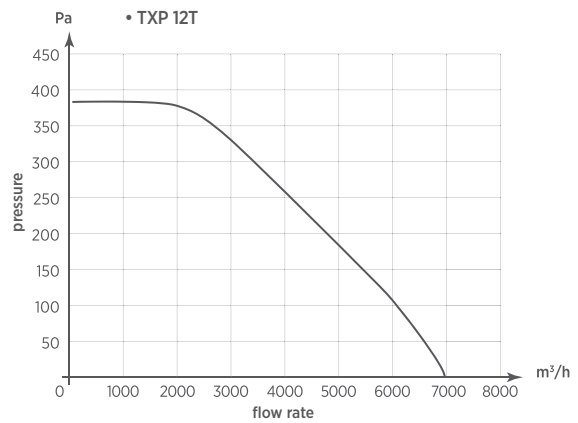
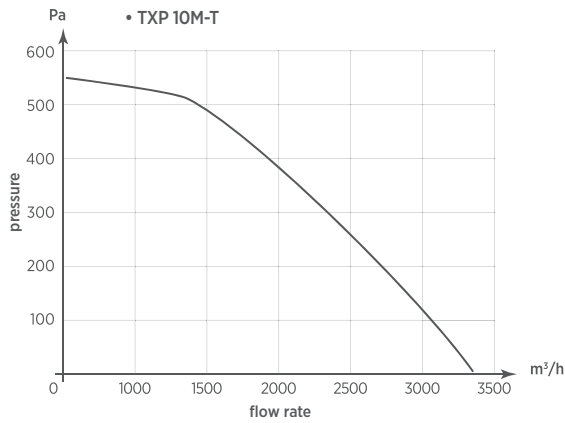
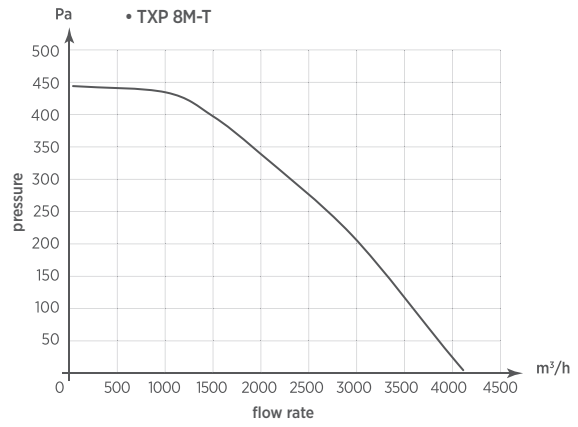
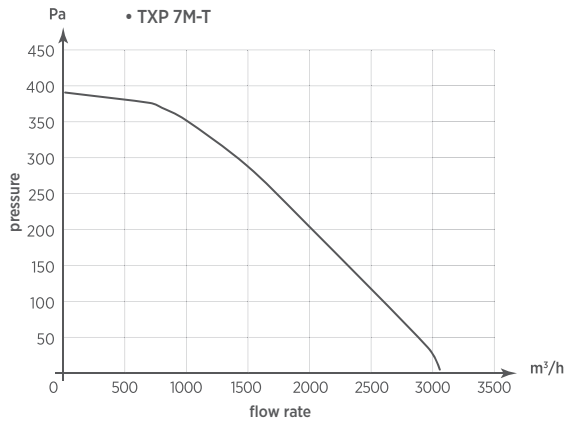

ACCESSORIES:
SEE PAGE 85



Controllers

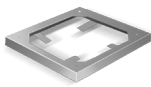

Frame base

Gravity shutter

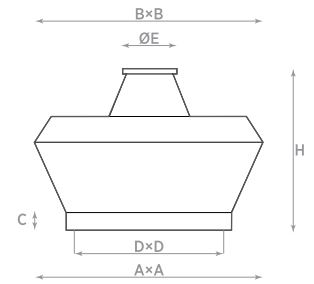

Model	A×A	B×B	C	D×D	ØE	H
TXV 3	400	590	40	350	200	480
TXV 6	400	590	40	350	250	500
TXV 7	560	780	40	460	300	630
TXV 8	560	780	40	460	350	630
TXV 10	710	930	40	610	400	700
TXV 12	900	1210	40	800	500	780
TXV 14	900	1210	45	800	550	820
TXV 15	900	1210	45	800	600	860
TXV 18	900	1210	45	800	600	900

TXV

ROOF FAN

The most powerful with vertical outlet. Ideal for medium/large sized structures.

- Centrifugal roof fans to extract air or fumes directly outside or through ducts;
- The vertical extracted air avoids to stain the lateral walls or components;
- Medium-high flow rates to overcome pressure losses due to duct resistance;
- Suitable for industrial and domestic environment: refectory kitchens and restaurants, sports facilities, shopping centres, industries, deposits, offices, toilets, apartments;
- Ball bearing class F insulation motor IP55 protected;
- Max temperature of extracted air: 60°C;

- Easy installation;
- Case in galvanized sheet steel;
- Safety protection outside grille;
- Self cleaning backward centrifugal impeller;
- Some models can be regulated through RGM or RGT controllers (see accessories);
- In accordance with the essential requirements of 2006/42/EC Directive concerning machines and European Standards UNI EN ISO 13857; UNI EN ISO 12499; CEI EN 60204-1.



POSITIONING

- Roof mounting

ENVIRONMENT APPLICATION

Suitable for both Industrial and civil application, such as canteens, restaurants, sports facilities, supermarkets and shopping centers, factories, warehouse,

offices, toilets and apartment buildings

TECHNICAL DATA

Model	Code	Motor	N° poles	Rev. per min. (RPM)	Voltage (Volt)	Frequency (Hz)	Flow rate (m³/h)	Max press. (mm H ₂ O)	Max press. (Pa)	Power (W)	Nom. curr. (A)		IP Motor protection	Noisiness (RPM)	Weight (Kg)
											230 V	400 V			
TXV 3M	0074120	single phase	4	1400	230	50-60	1200	20	196	120	0,81	-	IP55	60	20
TXV 6M	0074220	single phase	4	1400	230	50-60	1800	30	294	180	1,05	-	IP55	66	26
TXV 7M	0074320	single phase	4	1400	230	50-60	3100	40	392	250	1,4	-	IP55	69	35
TXV 8M	0074420	single phase	4	1400	230	50-60	4200	45	441	370	1,9	-	IP55	70	42
TXV 10M	0074520	single phase	4	1400	230	50-60	5700	56	549	750	3,4	-	IP55	75	55
TXV 3T	0074620	three phase	4	1400	230/400	50-60	1200	20	196	120	0,81	0,47	IP55	60	20
TXV 6T	0074720	three phase	4	1400	230/400	50-60	1800	30	294	180	1,05	0,6	IP55	66	26
TXV 7T	0074820	three phase	4	1400	230/400	50-60	3100	40	392	250	1,42	0,82	IP55	69	35
TXV 8T	0074920	three phase	4	1400	230/400	50-60	4200	45	441	370	1,9	1,1	IP55	70	42
TXV 10T	0075020	three phase	4	1400	230/400	50-60	5700	56	549	750	3,4	1,8	IP55	75	55
TXV 12T	0075120	three phase	6	900	230/400	50-60	7100	39	382	750	3,81	2,2	IP55	71	77
TXV 14T	0075220	three phase	6	900	230/400	50-60	10800	48	471	1100	5,37	3,1	IP55	75	100
TXV 15T	0075420	three phase	6	900	230/400	50-60	14200	57	559	2200	9,35	5,4	IP55	80	122
TXV 18T	0075520	three phase	6	900	230/400	50-60	18800	65	637	3000	11,95	6,90	IP55	84	138

FLOW CHARTS

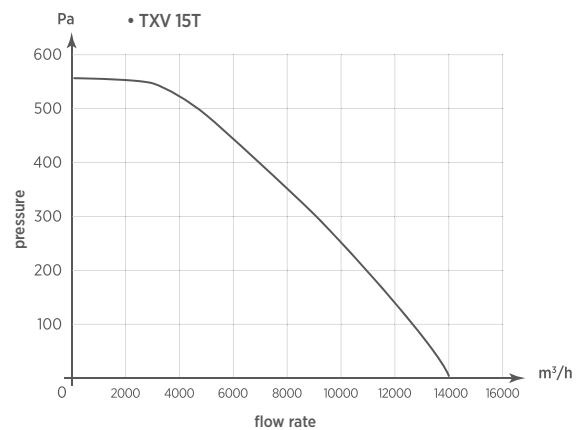
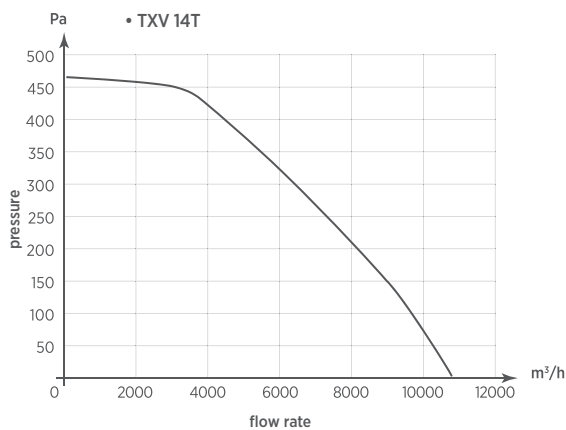
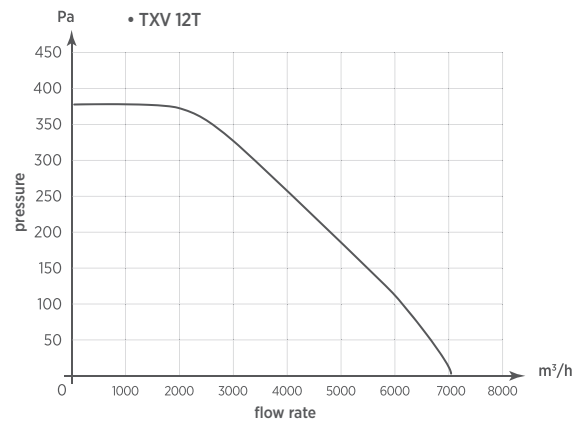
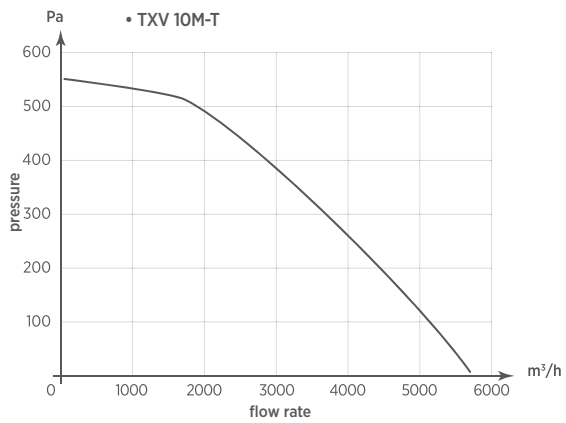
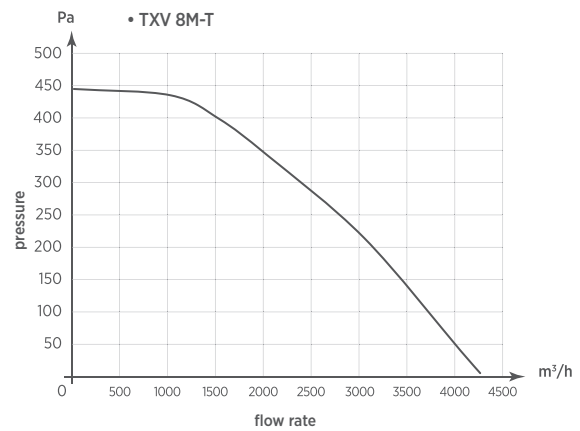
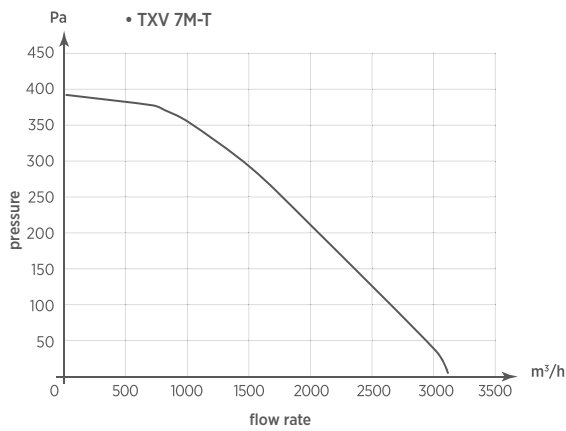
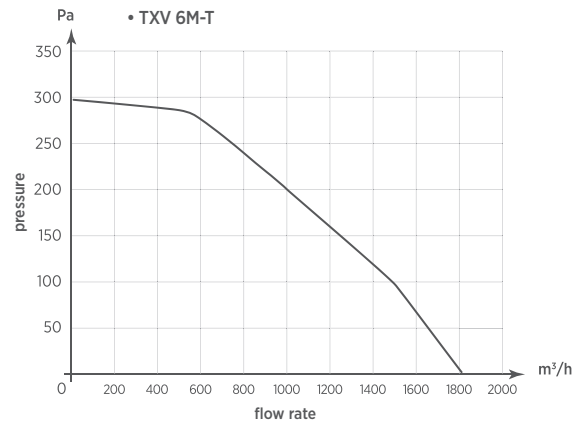
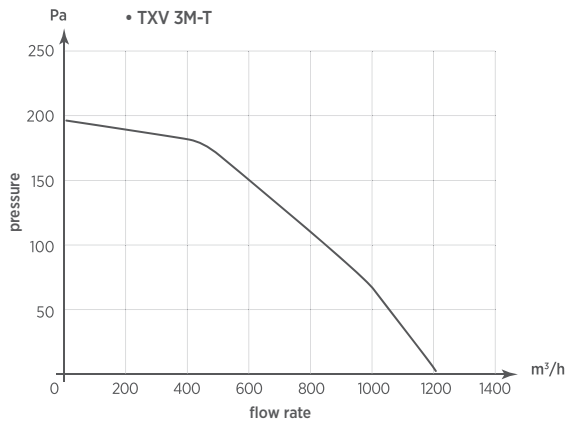

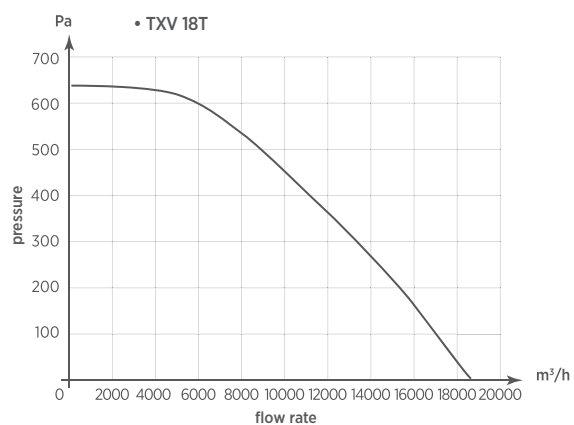

ACCESSORIES:

SEE PAGE 85



Controllers

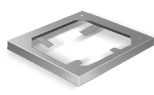

Frame
base

Gravity
shutter

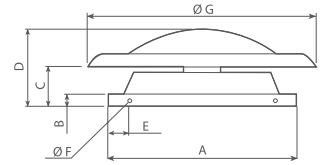
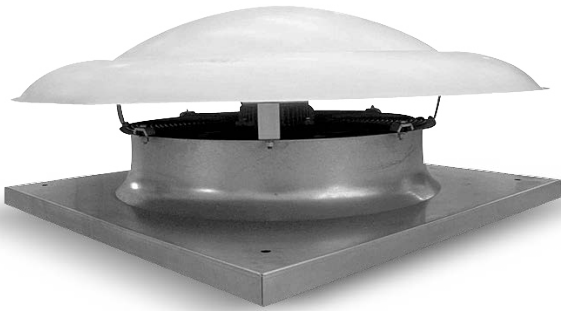

Modello	A	B	C	D	E	F	G
TXA 40 4T	660	45	138	300	100	12	710
TXA 50 4T	760	50	160	345	100	12	875
TXA 63 4T	890	55	185	362	100	12	1120
TXA 71 6T	950	50	155	409	100	12	1300
TXV 80 6T	1230	50	313	518	185	12	1300
TXV 100 6T	1400	50	335	600	170	12	1600

TXA

ROOF FANS

Axial roof fans with horizontal outlet. Ideal for medium/large sized structures.

- Axial roof fans to extract air or fumes directly outside or through ducts;
- High flow rates with low pressures;
- Suitable for industrial environments where is required to extract a big volume of air without ducts such as: warehouses, sheds, parking, greenhouses and breeding, sports facilities, supermarkets and commercial centres, industries;
- Ball bearing class F insulation motor IP55 protected;
- Max temperature of extracted air: 50°C;

- Easy installation;
- Case and air conveyor in galvanized steel sheet, cover protection in fibreglass RAL 7038 coloured, equipped with eyebolts for lifting;
- Safety protection outside grille;
- Double speed through switching star/delta;
- In accordance with the essential requirements of 2006/42/EC Directive concerning machines and European Standards UNI EN ISO 13857; UNI EN ISO 12499; CEI EN 60204-1.



POSITIONING

- Roof mounting

ENVIRONMENTS APPLICATION

Suitable for Industrial application:

- warehouse;
- industrial buildings;
- Car garages;
- greenhouses and breedings;
- Sport facilities;
- Supermarkets and Shopping centers;
- Factories.

TECHNICAL DATA

Model	Code	Marking	Motor	N° poles	Rev. per min. (RPM)	Voltage (Volt)	Frequency (Hz)	Flow rate (m³/h)	Power (W)	Nom. curr. (A) 400 V	IP Motor protection	Noisiness dB(A) _{2m}	Weight (Kg)
TXA 40 4T	0055010	II 2G c T3	single phase	4	900/1400	400	50-60	2900/3850	69	0,22/0,59	IP55	49/56	17
TXA 50 4T	0055020	II 2G c T3	single phase	4	900/1400	400	50-60	6250/7750	90	0,61/1,14	IP55	59/62	25
TXA 63 4T	0055030	II 2G c T6	three phase	4	900/1400	400	50-60	11900/13700	69	0,56/1,95	IP55	63/67	34
TXA 71 6T	0055040	II 2G c T6	three phase	6	700/900	400	50-60	10100/13200	90	0,85/1,73	IP55	57/63	47
TXA 80 6T	0055050	II 2G c T6	three phase	6	700/900	400	50-60	20300/23700	69	2,16/4,17	IP55	67/61	62
TXA 100 6T	0055060	II 2G c T6	three phase	6	700/900	400	50-60	26100/35500	90	3,8/8,2	IP55	66/73	90

FLOW CHARTS

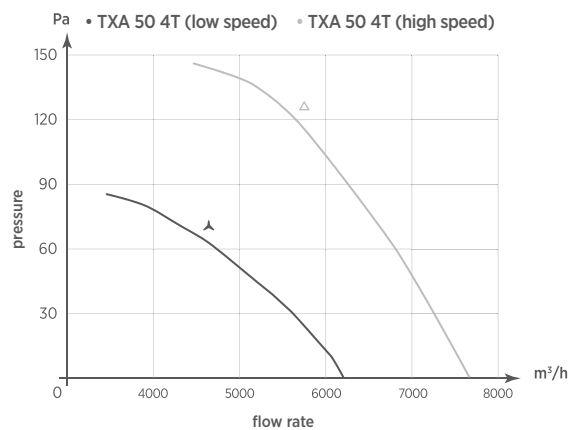
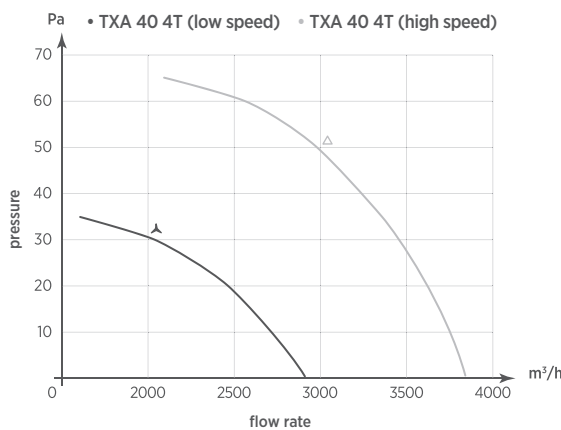

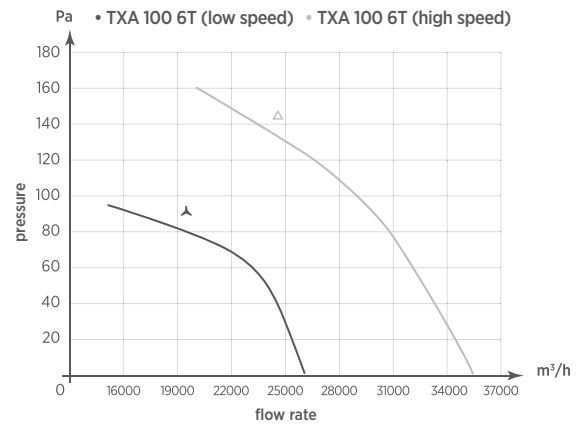
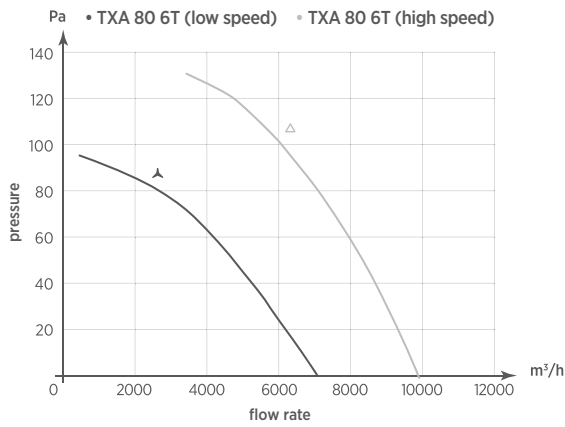
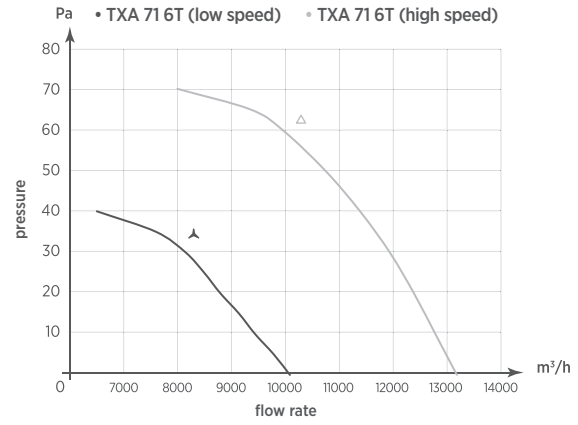
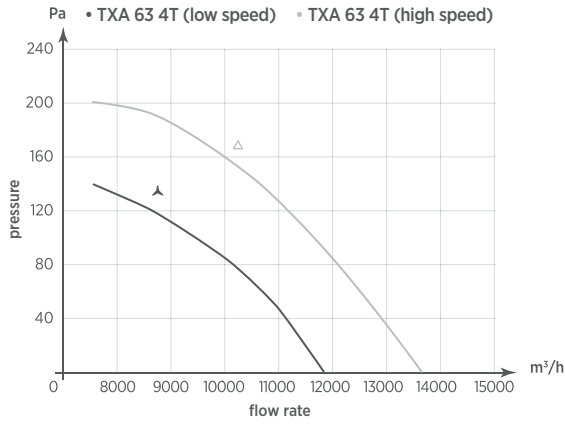

> **ACCESSORIES:**
SEE PAGE 85

Gravity shutter

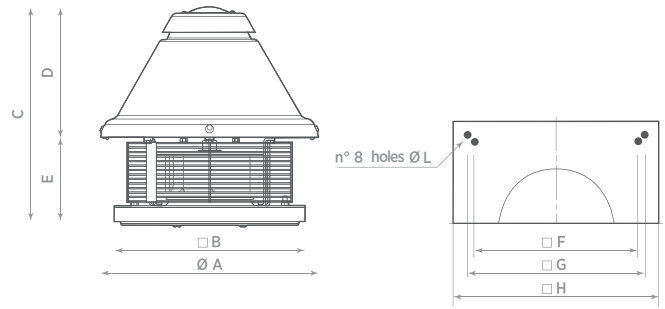

Model	Ø A	B	C	D	E	F	G	H	Ø L
Turbocamino	475	415	470	286	184	330	357	415	11

TURBOCAMINO

ROOF FAN FOR 200°C

- Centrifugal chimney roof fans for hot fumes (max 200°C)
- To extract hot dusty fumes/air smoke at temperature up to 200°C;
- Suitable for fireplaces, ovens waste or industrial hoods;
- For all chimneys with low natural draw;
- Ball bearing class F insulation motor IP55 protected;
- Aluminium protection cover;
- Self cleaning backward centrifugal zinc plated steel impeller statically and dynamically balanced;

- Safety protection outside grille;
- Provided with electronic speed controller RGE, for industrial use RGM2 available as accessory;
- The opening system allows easy access to the chimney for cleaning;
- In accordance with the essential requirements of 2006/42/EC Directive concerning machines and European Standards UNI EN ISO 13857; UNI EN ISO 12499; CEI EN 60204-1.



POSITIONING

- Roof mounting

ENVIRONMENTS APPLICATION

Suitable for all chimneys with insufficient up draught.

TECHNICAL DATA

Model	Code	Motor	N° poles	Rev. per min. (RPM)	Voltage (Volt)	Frequency (Hz)	Flow rate (m³/h)	Max press. (mm H ₂ O)	Max press. (Pa)	Power (W)	Nom. curr. (A) 230 V	IP Motor protection	Noisiness dB(A) _{2m}	Weight (Kg)
TURBOCAMINO	0055400	Single phase	4	1400	230	50-60	1200	19,5	191	110	0,6	IP55	52,5	15

FLOW CHARTS

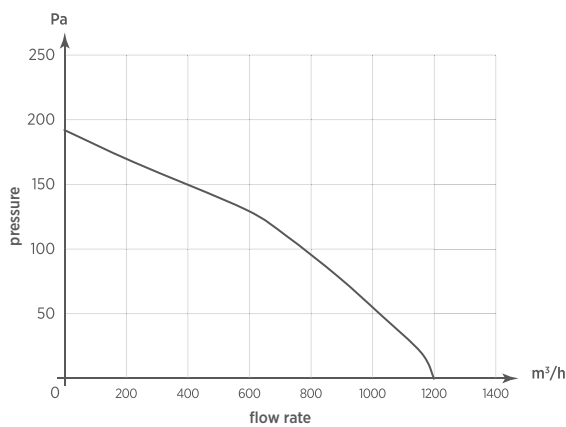

FURTHER INFORMATION

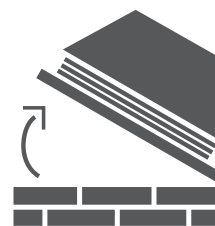

Compass opening for easy access to the chimney.

ACCESSORIES:

SEE PAGE 85



Controllers

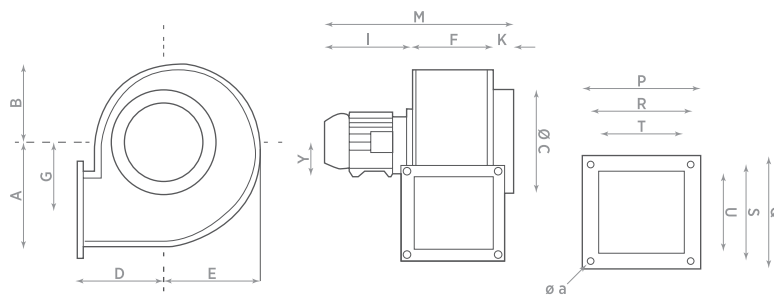
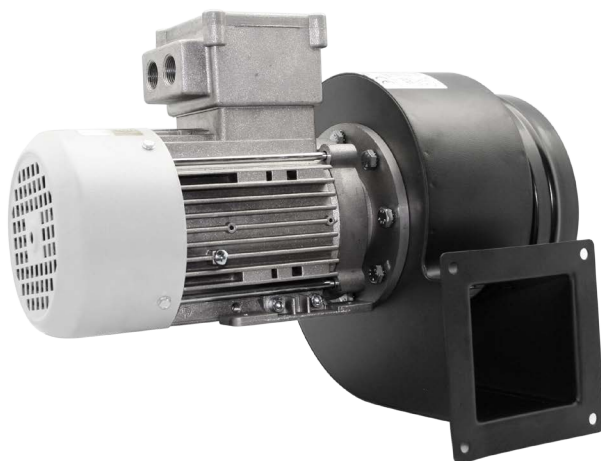

Model	A	B	ØC	D	E	F	G	H	Y	K	I	L	M	N	O	P	Q	R	S	T	U	z*	Øa	Øb
CB 230 Ex-ATEX	139	108	180	127	122	94	91	-	63	42	242	-	378	-	-	135	135	114	114	88	90	4	8,2	-
CB 240 Ex-ATEX	172	128	200	146	150	112	117	-	63	45	242	-	399	-	-	152	152	126	126	105	105	4	8,2	-

z* = number of holes

CB EX-ATEX

EXPLOSION PROOF FANS EX-ATEX

Explosion Proof Certified Centrifugal fans to extract air and fumes through medium/long sized ducts in compliance with ATEX Directive 84/9/EEC effective from July 1st 2003 in EU.

- Suitable for applications in commercial and industrial environments where the risk of explosion is high and where the surrounding atmosphere contains gas, vapours or highly inflammable steam;
- The whole product and not just the electrical parts, has been certified by CESI Institute with CESI n° 03 ATEX 250;
- Fan group II, cat. 2 for gases, construction safety C, max surface temp. T4 (135°C), available on demand T5 and/or T6;
- Classified for zones 1 and 2;

- This approval homologation has required specific safety tests and proper examinations on products to verify how the adopted solutions have satisfied the essential Directive requirements;
- Steel plated frame protected by an epoxy-based anticorrosive paint and aluminium centrifugal impeller statically and dynamically balanced;
- Ball bearing class F insulation motor IP55 protected;
- Max temperature of extracted air: 60°C;
- Standard product supplied with impeller housing position CCW 270, different positions available on request (see table on page 89);
- Reference Standards: EN 13463-1; EN 13463-5; EN 14986.



POSITIONING

- Wall mounting

ENVIRONMENTS APPLICATION

suitable for Industrial, civil and commercial application where the risk of explosion is high.

- Shops;
- Workshops;
- Sports facilities;

- Supermarkets and shopping centers;
- Warehouse;
- Factories;
- Machinery.

TECHNICAL DATA

Model	Code	Marking	Motor	N° poles	Rev. per min. (RPM)	Voltage (Volt)	Frequency (Hz)	Flow rate (m³/h)	Max press. (mm H ₂ O)	Max press. (Pa)	Power (W)	Nom. curr. (A) 230 V	400 V	IP Motor protection	Noisiness dB(A) _{2m}	Weight (Kg)
CB 230 2M Ex-ATEX	0032300	II 2G c T4	single phase	2	2750	230	50	1000	69	677	450	2,5	-	IP55	76	10,0
CB 240 2M Ex-ATEX	0032400	II 2G c T4	single phase	2	2800	230	50	1450	90	883	850	3,8	-	IP55	83	12,0
CB 230 2T Ex-ATEX	0031900	II 2G c T4	three phase	2	2750	230/400	50	1000	69	677	400	1,4	0,8	IP55	76	10,0
CB 240 2T Ex-ATEX	0032000	II 2G c T4	three phase	2	2800	230/400	50	1450	90	883	800	2,3	1,3	IP55	83	12,0

FLOW CHARTS

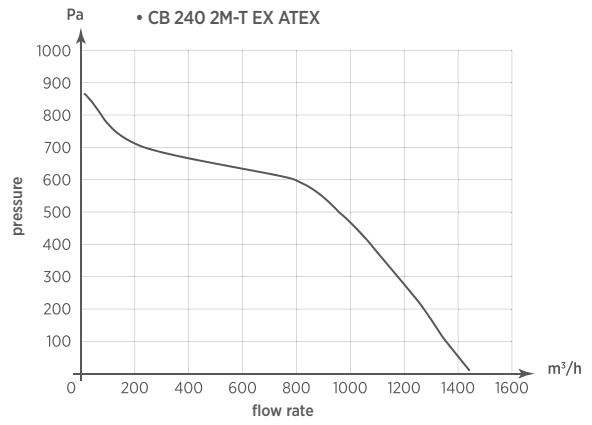
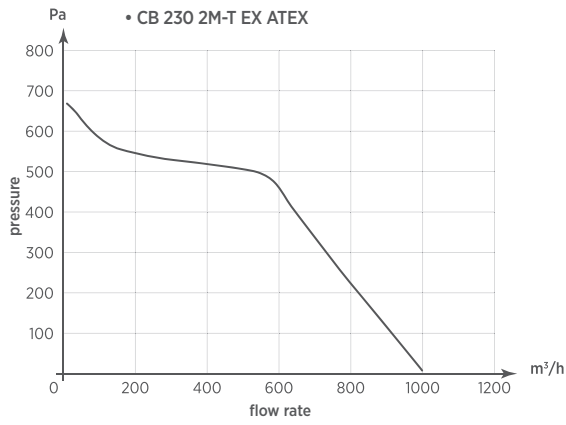

ACCESSORIES (SUITABLE FOR INSTALLATION OUTSIDE OF THE EX ATEX AREA)
SEE PAGE 85



Controllers

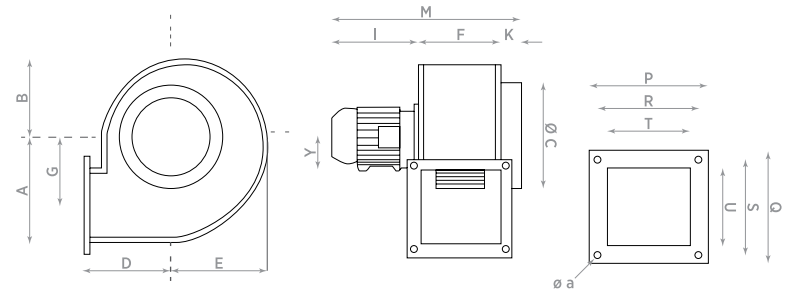
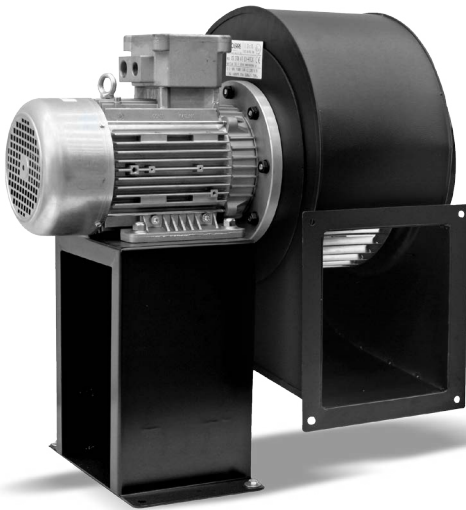

Model	A	B	ØC	D	E	F	G	H	Y	K	I	L	M	N	O	P	Q	R	S	T	U	z	Øa	Øb
CS 310 Ex-ATEX	139	108	180	127	122	94	91	-	63	42	242	-	378	-	-	135	135	114	114	88	90	4	8,2	-
CS 320 Ex-ATEX	172	128	200	146	150	112	117	-	63	45	242	-	399	-	-	152	152	126	126	105	105	4	8,2	-
CS 330 Ex-ATEX	209	163	250	147	188	141	139	-	71	40	242	-	423	-	-	191	191	165	165	134	134	4	8,2	-
CS 340 Ex-ATEX	250	194	250	178	222	164	162	-	80	45	259	-	468	-	-	225	235	195	205	161	170	4	8,2	-
CS 350 Ex-ATEX	290	225	315	210	260	194	192	245	80	50	259	232	503	120	149	255	255	225	225	191	194	4	8,2	11
CS 360 Ex-ATEX	290	225	315	210	260	194	192	245	90	50	300	232	544	120	155	255	255	225	225	191	194	4	8,2	11
CS 370 Ex-ATEX	334	244	355	230	250	221	210	350	100	50	354	325	625	170	173	284	305	254	275	213	244	4	10,2	11
CS 380 Ex-ATEX	429	315	400	300	370	249	280	350	112	62	358	325	669	170	194	310	360	280	330	241	295	8	9	11

CS EX-ATEX

EXPLOSION PROOF FANS EX-ATEX

Explosion Proof Certified Centrifugal fans to extract air and fumes through medium/long sized ducts in compliance with ATEX Directive 84/9/EEC effective from July 1st 2003 in EU.

- Suitable for applications in commercial and industrial environments where the risk of explosion is high and where the surrounding atmosphere contains gas, vapours or highly inflammable steam;
- The whole product and not just the electrical parts, has been certified by CESI institute with CESI n°03 ATEX 250 certificate;
- Fan group II, cat. 2 for gases, construction safety C, max surface temp. T3 (200°C);
- Classified for zones 1 and 2;
- This approval has required specific safety tests and proper examinations

on products to verify how the adopted solutions have satisfied the essential Directive requirements;

- Steel plated frame protected by an epoxy-based anticorrosive paint and aluminium centrifugal impeller statically and dynamically balanced;
- Ball bearing class F insulation motor IP55 protected;
- Max temperature of extracted air: 60°C;
- Models CS 350, 360, 370 and 380: mounted on rigid base support to make installation easier;
- Standard product supplied with impeller housing position CCW 270, different positions available on request (see table on page 89);
- Reference Standards: EN 13463-1; EN 13463-5; EN 14986.



POSITIONING

- Wall mounting

ENVIRONMENTS APPLICATION

Suitable for Industrial, civil and commercial application where the risk of explosion is high.

- Shops
- Workshops
- Sports facilities

- Supermarkets and shopping centers
- Warehouse
- Factories
- Machinery

TECHNICAL DATA

Model	Code	Marking	Motor	N° poles	Rev. per min. (RPM)	Voltage (Volt)	Frequency (Hz)	Flow rate (m³/h)	Max press. (mm H ₂ O)	Max press. (Pa)	Power (W)	Nom. Curr. (A) 230 V	400 V	IP Motor protection	Noisiness dB(A) _{2m}	Weight (Kg)
CS 310 4M Ex-ATEX	0032500	II 2G c T4	Single phase	4	1400	230	50	500	16	157	200	1	-	IP55	64	13,0
CS 320 4M Ex-ATEX	0032700	II 2G c T4	Single phase	4	1400	230	50	720	21	206	250	1,5	-	IP55	67	14,0
CS 310 4T Ex-ATEX	0032600	II 2G c T4	Three phase	4	1400	230/400	50	500	16	157	200	1	0,59	IP55	64	13,0
CS 320 4T Ex-ATEX	0032800	II 2G c T4	Three phase	4	1400	230/400	50	720	21	206	250	1,75	1	IP55	67	14,0
CS 330 4T Ex-ATEX	0032900	II 2G c T4	Three phase	4	1400	230/400	50	1500	38	373	400	1,9	1,1	IP55	70	21,0
CS 340 4T Ex-ATEX	0032100	II 2G c T4	Three phase	4	1400	230/400	50	1900	47	461	1000	3,5	2	IP55	73	31,0
CS 350 4T Ex-ATEX	0033000	II 2G c T4	Three phase	4	1400	230/400	50	2900	50	490	1400	4	2,31	IP55	76	37,0
CS 360 4T Ex-ATEX	0032200	II 2G c T4	Three phase	4	1400	230/400	50	4100	60	589	1900	5,7	3,3	IP55	80	44,0
CS 370 4T Ex-ATEX	0033100	II 2G c T4	Three phase	4	1400	230/400	50	5600	73	716	2500	8,7	5	IP55	84	67,0
CS 380 4T Ex-ATEX	0033800	II 2G c T4	Three phase	4	1400	230/400	50	9100	105	1030	4500	15,6	9	IP55	88	91,0

FLOW CHARTS

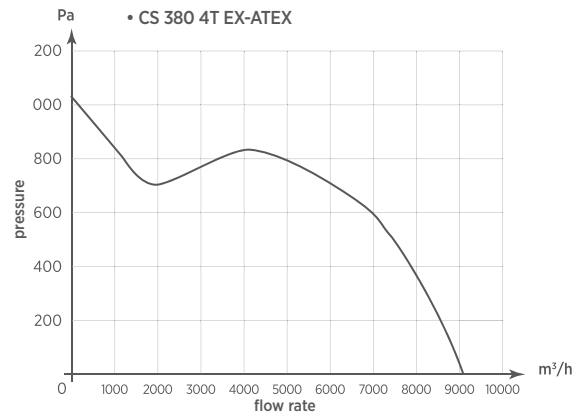
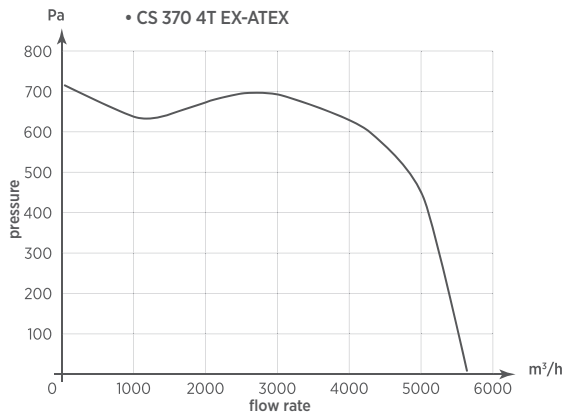
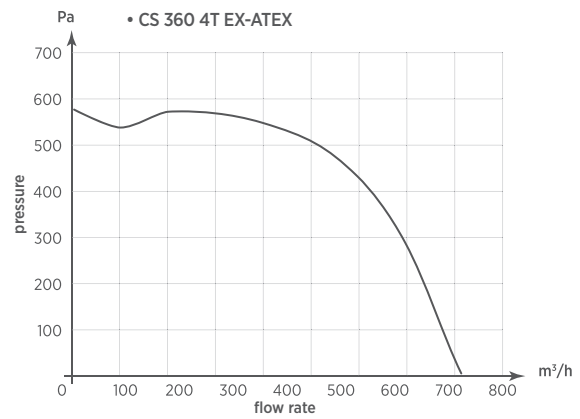
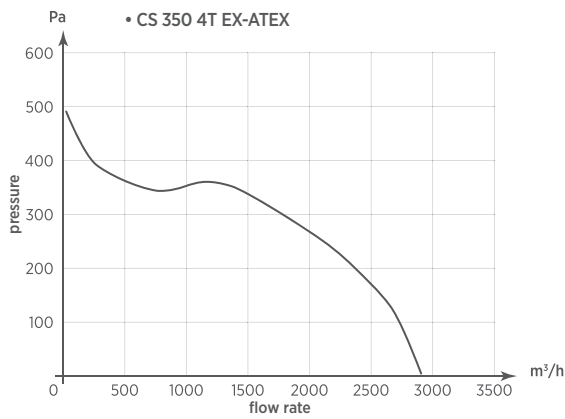
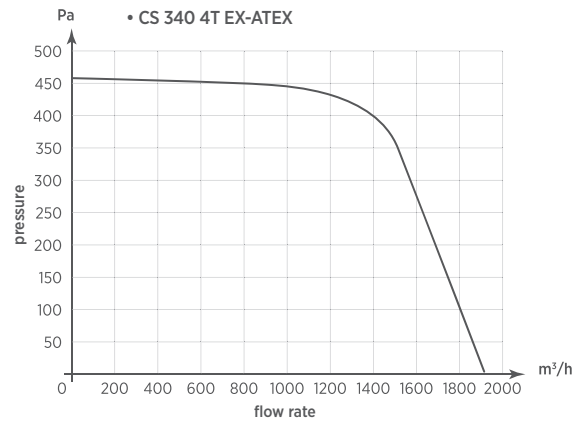
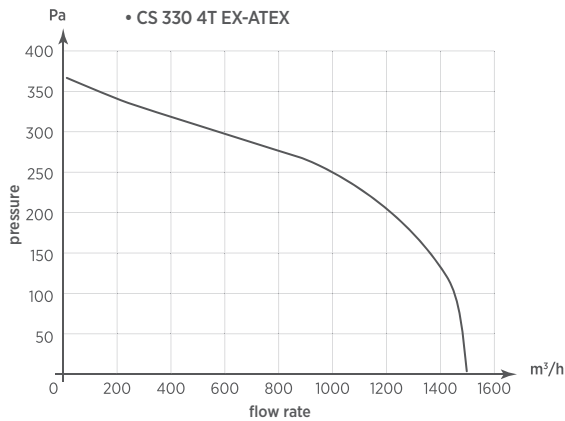
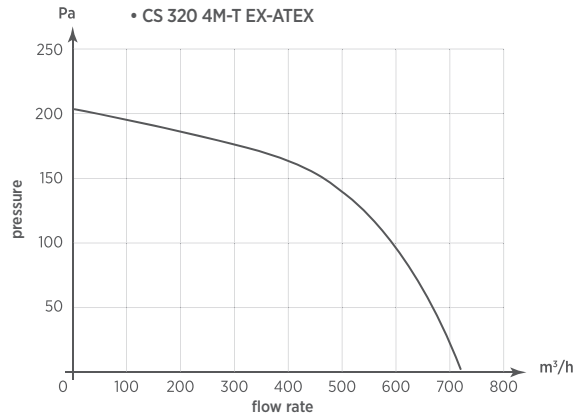
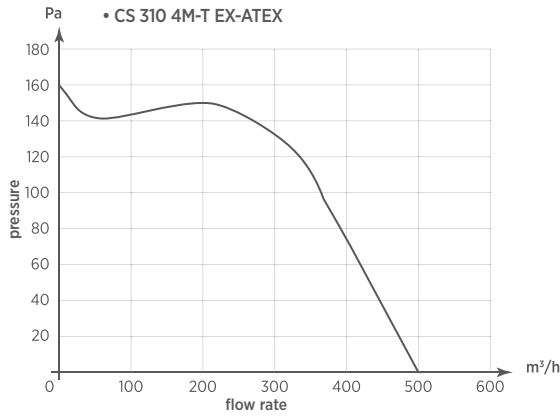

ACCESSORIES (SUITABLE FOR INSTALLATION OUTSIDE OF THE EX ATEX AREA)
SEE PAGE 85



Controllers

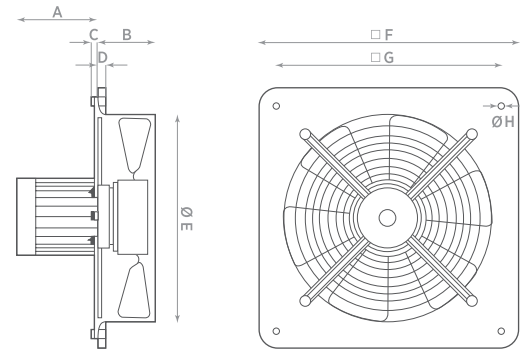

Model	A	B	C	D	E	F	G	ØH
EB 25 4M/T Ex-ATEX	190	66	9	8	260	340	325	8,3
EB 30 4M/T Ex-ATEX	190	75	9	10	312	390	375	8,3
EB 35 4M/T Ex-ATEX	190	85	10	12	365	460	439	12,3
EB 40 4M/T Ex-ATEX	190	85	10	12	415	510	490	12,3
EB 50 4M/T Ex-ATEX	190	101	10	15	515	630	610	12,3

EB EX-ATEX

ANTIDEFLAGRANTI EX-ATEX

Explosion Proof Certified Axial fans to extract air and fumes directly outside through short ducting, wall or panel mounting, in compliance with ATEX Directive 84/9/EEC effective from July 1st 2003 in EU.

- Suitable for applications in commercial and industrial environments where the risk of explosion is high and where the surrounding atmosphere contains gas, vapours or highly inflammable steam;
- The whole product and not just the electrical parts, has been certified by CESI Institute with CESI n°3 ATEX 251 certificate;
- Fan group II, cat. 2 for gases, construction safety C, max surface temp. T4 (135°C) available on demand T5 and/or T6;

- Classified for zones 1 and 2;
- This approval has required specific safety tests and proper examinations on products to verify how the adopted solutions have satisfied the essential Directive requirements;
- Steel plated body protected by an epoxy-based anticorrosive paint;
- Impeller made of VO reinforced conductive nylon;
- Exd-II B - T4, ball bearing class F insulation motor IP55 protected;
- Max temperature of extracted air: 40°C;
- Reversibility: all models;
- Reference Standards: EN 13463-1; EN 13463-5; EN 14986.



POSITIONING

- Wall mounting

ENVIRONMENTS APPLICATION

Suitable for Industrial, civil and commercial application where the risk of explosion is high.

- Shops;
- Workshops;
- Sports facilities;
- Supermarkets and shopping centers;
- Warehouse;
- Factories;
- Machinery.

TECHNICAL DATA

Model	Code	Marking	Motor	N° poles	Rev. per min. (RPM)	Voltage (Volt)	Frequency (Hz)	Flow rate (m³/h)	Max press. (mm H₂O)	Max press. (Pa)	Power (W)	Nom. curr. (A)		Noisiness dB(A) _{2m}	Weight (Kg)
												230 V	400 V		
EB 25 4M Ex-ATEX	0035400	II 2G c T4	single phase	4	1460	230	50	900	10	98	120	0,7	-	55	10,0
EB 30 4M Ex-ATEX	0035500	II 2G c T4	single phase	4	1400	230	50	1500	12	118	140	0,75	-	59	10,0
EB 35 4M Ex-ATEX	0035600	II 2G c T4	single phase	4	1350	230	50	2250	10	98	160	0,8	-	62	11,0
EB 40 4M Ex-ATEX	0035000	II 2G c T4	single phase	4	1290	230	50	2900	9	88	180	0,85	-	65	12,0
EB 50 4M Ex-ATEX	0035100	II 2G c T4	single phase	4	1200	230	50	4500	14	137	210	1	-	70	14,0
EB 25 4T Ex-ATEX	0035700	II 2G c T4	three phase	4	1460	230/400	50	900	10	98	100	0,67	0,39	55	9,0
EB 30 4T Ex-ATEX	0035900	II 2G c T4	three phase	4	1430	230/400	50	1500	12	118	125	0,69	0,40	59	9,0
EB 35 4T Ex-ATEX	0036000	II 2G c T4	three phase	4	1400	230/400	50	2250	10	98	150	0,72	0,42	63	10,0
EB 40 4T Ex-ATEX	0036100	II 2G c T4	three phase	4	1350	230/400	50	2900	9	88	180	0,74	0,43	66	11,0
EB 50 4T Ex-ATEX	0036200	II 2G c T4	three phase	4	1270	230/400	50	4500	14	137	230	0,78	0,45	72	13,0

FLOW CHARTS

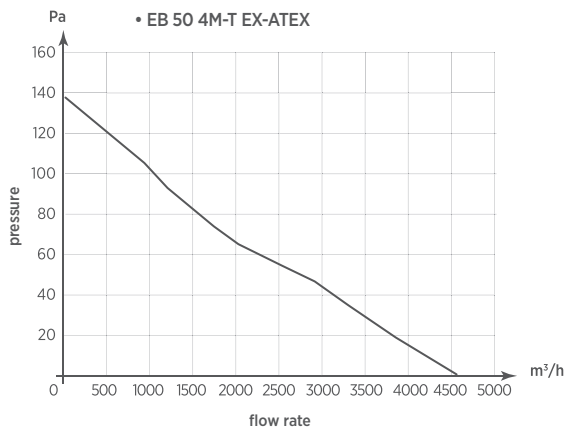
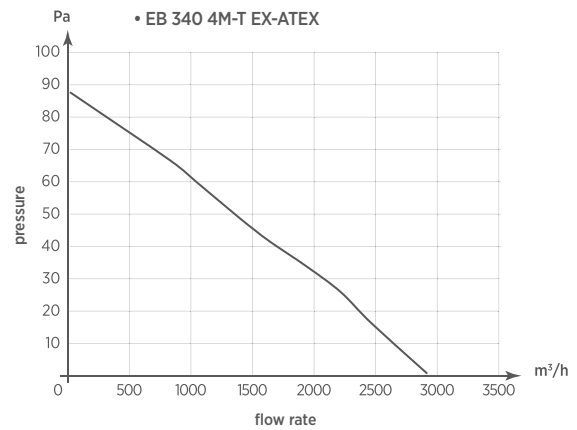
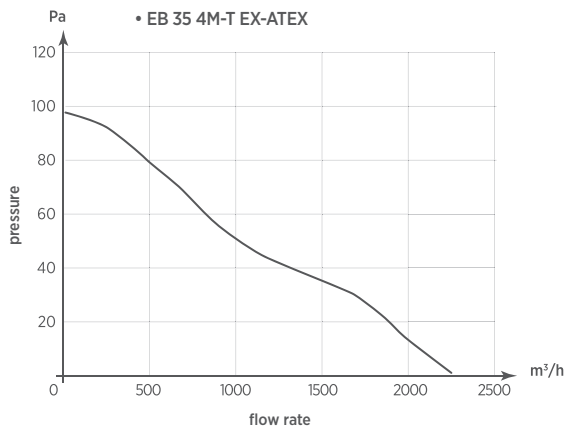
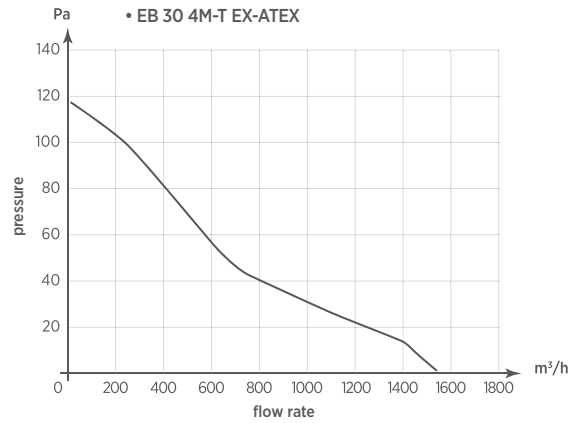
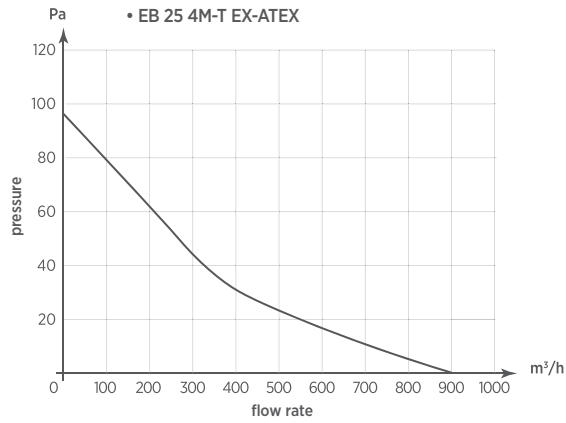

ACCESSORIES: SEE PAGE 85



Protection grille



Gravity shutter

ACCESSORIES (SUITABLE FOR INSTALLATION OUTSIDE OF THE EX ATEX AREA) SEE PAGE 85



Controllers

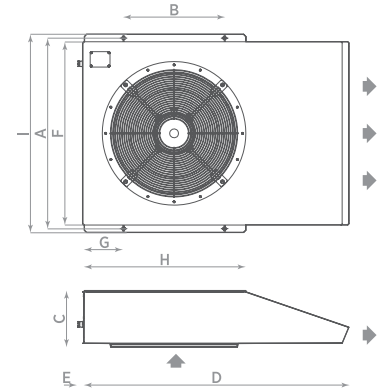

Model	A	B	C	D	E	F	G	H	I
PVI-HT 250-50	870	515	251,5	1206	25	830	186	739	900
PVI-HT 250-100	870	515	250	1200	25	830	186	740	900
PVI-HT 300-100	1030	460	305	1450	25	1000	240	850	1070

PVI -HT

SMOKE EXHAUST FANS FOR FIRE AND CAR GARAGES

Induction fans are designed for forced ventilation of underground car parkings. They are used, in normal conditions, to remove pollutants from the garage (i.e. CO₂) and, in emergency conditions (fire), to convey smokes and other combustion fumes towards the evacuation shaft. The most relevant characteristic of the induction ventilation system is the absence of ducting and hence the following advantages are there:

- Lower cost of the complete system
- Lower running costs
- Higher flexibility
- Lower vertical obstruction
- Lower maintenance cost

PVI-HT fans are designed and manufactured according to the European Standard EN 12101-3 and have been certified by an Acknowledged Qualified Institute.

PVI-HT range is suitable for continuous service at 40°C air temperature and, in case of fire (emergency) at 300°C for 2 hours (F300). The series is composed by two models with thrust of 50Nw and 100 Nw.

Construction features

- Self supporting structure in steel sheet with corrosion resistant finish
- Backward bladed impeller with high efficiency in galvanized steel sheet, balanced according to UNI-ISO 1940
- Intake safety grid with anticorrosion treatment
- Two-speed asynchronous 3-phase motor, suitable for continuous service at 40°C and for 2 hours at 300°C (F300)
- Built-in service switch & terminal box

On request, PVI-HT series is available with standard motor, only suitable for evacuation of polluting gases.



POSITIONING

- Ceiling mounting

ENVIRONMENTS APPLICATION

Suitable for forced ventilation of:

- Shopping centers

- underground car parkings.

TECHNICAL DATA

Model	Code	Motor	N° poles	Rev. per min. (RPM)	Voltage (Volt)	Frequency Hz	Air speed (m/s)	Power (kW)	Nom. curr. (A) 400 V	Noisiness dB(A) _{1m}	Weight (Kg)
PVI-HT 250-50	0012700	Three phase	4/8	1400/700	400	50	23/11	1,2/0,3	3,3/1,4	74/58	67
PVI-HT 250-50/F300	0012710	Three phase	4/8	1400/700	400	50	23/11	1,2/0,3	3,3/1,4	74/58	67
PVI-HT 300-100	0012705	Three phase	4/8	1400/700	400	50	28/13,5	2,2/0,55	5,8/2,0	76/60	99
PVI-HT 300-100/F300	0012715	Three phase	4/8	1400/700	400	50	28/13,5	2,2/0,55	5,8/2,0	76/60	99

FURTHER INFORMATION

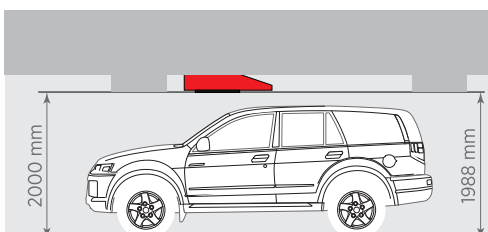

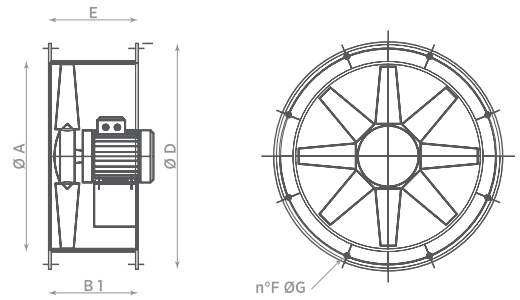
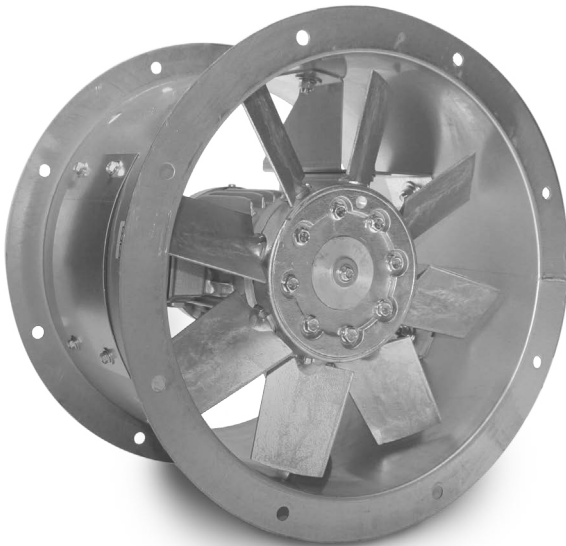

Model	A	B1	ØC	D	E	F	G
AXIA AI HT 40	410	260	450	490	300/390	8	12
AXIA AI HT 45	460	260	500	540	350/430	8	12
AXIA AI HT 50	510	260	560	595	350/440	12	12
AXIA AI HT 55	570	260	620	655	350/440	12	12
AXIA AI HT 60	640	350	690	725	400/490	12	12
AXIA AI HT 70	710	350	770	805	400/560	16	12
AXIA AI HT 80	807	600	860	900	600	16	23
AXIA AI HT 90	910	700	970	1010	700	16	23
AXIA AI HT 100	1010	700	1070	1110	700	16	23
AXIA AI HT 125	1265	900	1315	1355	900	16	23

AXIA AI HT

SMOKE EXHAUST FANS FOR FIRE AND CAR GARAGES

AXIA AI-HT fans are designed to be used in installations where the smoke exhaust in case of fire is prescribed (mainly buildings open to public), according to the European Standard EN 12101-3.

Products certified by an Acknowledged Qualified Institute.

The AXIA AI-HT range is suitable for continuous service at 40°C air temperature and, in case of fire (emergency service), at 300°C for 60 minutes (F300) or at the temperature of 400°C for 120 minutes (F400).

The series is composed by 6 sizes, with airflow up to 20.000 m³/h.

- Impeller in die cast aluminum alloy with aerofoil profile, with variable pitch

angle in still condition;

- Hub in die cast aluminum alloy;
- Balancing according to UNI ISO 1940 standard;
- Casing in steel sheet, with protective epoxy painting;
- Flanges according to UNI ISO 13351 standard;
- 3-phase electric motor, IP55, B3 mounting, according to IEC/EEC standard, suitable and certified for continuous service at 40°C and at 300°C for 60 minutes in case of fire (F300) and at 400°C for 120 minutes (F400)
- Bigger sizes and higher performances are available on request.



POSITIONING

- Duct mounting

ENVIRONMENTS APPLICATION

Suitable for system of evacuation in case of fire such as:

- Shopping centers
- Hospital
- Theaters
- Underground parking
- Schools
- Museums
- Buildings and skyscrapers.

TECHNICAL DATA

Model	Code		Motor	N° Poles	Rev. per min. (RPM)	Tension (Volt)	Flow rate (m³/h)	Max press. (mm H₂O)	Max press. (Pa)	Power (kW)	Nom. Curr (A)		IP Motor protection	Noisiness dB(A) _{3m}	Weight (Kg)
	F300	F400									230 V	400 V			
AXIA AI HT 40 2T	-	0013391	Three phase	2	2865	400	8900	56,1	550	1,5	5,4	3,1	IP55	78	25
AXIA AI HT 40 4T	0013201	0013301	Three phase	4	1420	400	5900	11,2	110	0,55	2,6	1,5	IP55	63	23
AXIA AI HT 45 2T	-	0013393	Three phase	2	2880	400	13000	56,1	550	3,0	10,3	5,9	IP55	82	26
AXIA AI HT 45 4T	0013203	0013303	Three phase	4	1420	400	7300	14,3	140	0,55	2,3	1,3	IP55	67	22
AXIA AI HT 45 4T-P	0013205	0013305	Three phase	4	1420	400	8600	19,4	190	0,55	2,3	1,3	IP55	69	24
AXIA AI HT 50 4T	0013207	0013307	Three phase	4	1420	400	9000	21,4	210	0,55	2,3	1,3	IP55	72	32
AXIA AI HT 50 6T	0013209	0013309	Three phase	6	920	400	6000	7,1	70	0,55	2,3	1,3	IP55	60	30
AXIA AI HT 55 4T	0013211	0013311	Three phase	4	1415	400	13000	24,5	240	0,75	3,0	1,7	IP55	70	38
AXIA AI HT 55 4T-P	0013213	0013313	Three phase	4	1410	400	14000	27,5	270	1,1	4,3	2,5	IP55	73	41
AXIA AI HT 55 6T	0013215	0013315	Three phase	6	1420	400	9000	10,2	100	0,37	2,2	1,3	IP55	64	36
AXIA AI HT 60 4T	0013217	0013317	Three phase	4	1420	400	17000	25,5	250	1,1	4,2	2,4	IP55	76	65
AXIA AI HT 60 4T-P	0013219	0013319	Three phase	4	1410	400	22000	27,5	270	2,2	8,1	4,6	IP55	77	69
AXIA AI HT 60 6T	0013221	0013321	Three phase	6	910	400	9800	10,2	100	0,55	2,6	1,5	IP55	60	64
AXIA AI HT 60 6T-P	0013223	0013323	Three phase	6	920	400	15600	10,8	106	0,75	3,4	2,0	IP55	68	61
AXIA AI HT 70 4T	0013225	0013325	Three phase	4	1430	400	23000	35,7	350	2,2	8,1	4,6	IP55	79	80
AXIA AI HT 70 4T-P	0013227	0013327	Three phase	4	1430	400	32000	40,8	400	4	14,4	8,3	IP55	81	88
AXIA AI HT 70 6T	0013229	0013329	Three phase	6	925	400	18200	17,8	175	0,75	3,4	2,0	IP55	71	78
AXIA AI HT 70 6T-P	0013231	0013331	Three phase	6	925	400	22500	18,3	180	1,1	4,8	2,8	IP55	72	75
AXIA AI HT 80 4T	-	0013333	Three phase	4	1440	400	22000	46,9	460	3	11,3	6,5	IP55	79	120
AXIA AI HT 80 4T-P	-	0013335	Three phase	4	1440	400	30000	51,0	500	4	14,4	8,3	IP55	82	125
AXIA AI HT 80 4T-DP	-	0013337	Three phase	4	1460	400	36000	55,0	540	5,5	18,3	10,5	IP55	84	130
AXIA AI HT 80 6T	-	0013339	Three phase	6	925	400	18500	17,3	170	0,75	3,4	2,0	IP55	72	120
AXIA AI HT 80 6T-P	-	0013341	Three phase	6	935	400	26600	19,4	190	1,1	4,8	2,8	IP55	73	115
AXIA AI HT 80 6T-DP	-	0013343	Three phase	6	940	400	29400	19,9	195	1,5	6,4	3,7	IP55	75	110
AXIA AI HT 90 4T	-	0013345	Three phase	4	1460	400	46000	66,3	650	5,5	18,3	10,5	IP55	85	188

Model	Code F300	Code F400	Motor	N° Poles	Rev. per min. (RPM)	Tension (Volt)	Flow rate (m³/h)	Max press. (mm H₂O)	Max press. (Pa)	Power (kW)	Nom. curr. (A) 230 V 400 V	IP Motor protection	Noisiness dB(A) _{1m}	Weight (Kg)
AXIA AI HT 90 4T-P	-	0013347	Three phase	4	1455	400	50000	69,3	680	7,5	24,5 14,1	IP55	87	195
AXIA AI HT 90 4T-DP	-	0013349	Three phase	4	1450	400	59000	70,3	690	11	36,9 21,2	IP55	90	200
AXIA AI HT 90 6T	-	0013351	Three phase	6	940	400	32000	24,5	240	1,5	6,5 3,7	IP55	78	175
AXIA AI HT 90 6T-P	-	0013353	Three phase	6	955	400	37000	24,5	240	2,2	10,3 5,9	IP55	80	180
AXIA AI HT 90 6T-DP	-	0013355	Three phase	6	955	400	42000	25,5	250	3	12,7 7,3	IP55	81	185
AXIA AI HT 100 4T	-	0013357	Three phase	4	1455	400	58000	76,5	750	7,5	24,5 14,1	IP55	89	240
AXIA AI HT 100 4T-P	-	0013359	Three phase	4	1470	400	68000	64,2	630	11	36,9 21,2	IP55	90	247
AXIA AI HT 100 4T-DP	-	0013361	Three phase	4	1465	400	83000	66,3	650	15	49,9 28,7	IP55	92	258
AXIA AI HT 100 6T	-	0013363	Three phase	6	960	400	44000	30,6	300	3	11,3 6,5	IP55	80	240
AXIA AI HT 100 6T-P	-	0013365	Three phase	6	960	400	52000	31,6	310	4	16,5 9,5	IP55	82	235
AXIA AI HT 100 6T-DP	-	0013367	Three phase	6	960	400	57000	31,6	310	5,5	22,3 12,8	IP55	84	228
AXIA AI HT 125 4T	-	0013369	Three phase	4	1455	400	90000	89,7	880	22	69,7 40,1	IP55	95	340
AXIA AI HT 125 4T-P	-	0013371	Three phase	4	1470	400	115000	89,7	880	30	97,2 55,9	IP55	96	345
AXIA AI HT 125 4T-DP	-	0013373	Three phase	4	1475	400	135000	89,7	880	37	111,1 63,9	IP55	98	350
AXIA AI HT 125 6T	-	0013375	Three phase	6	960	400	72000	39,8	390	5,5	22,3 12,8	IP55	87	290
AXIA AI HT 125 6T-P	-	0013377	Three phase	6	970	400	86000	40,8	400	7,5	26,1 15,0	IP55	87	295
AXIA AI HT 125 6T-DP	-	0013379	Three phase	6	970	400	100000	42,8	420	11	38,3 22,0	IP55	90	300

FLOW CHARTS

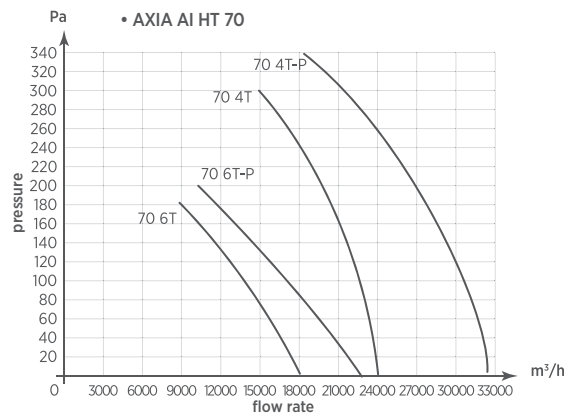
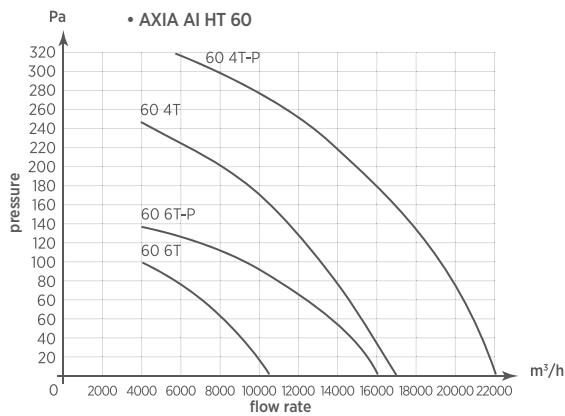
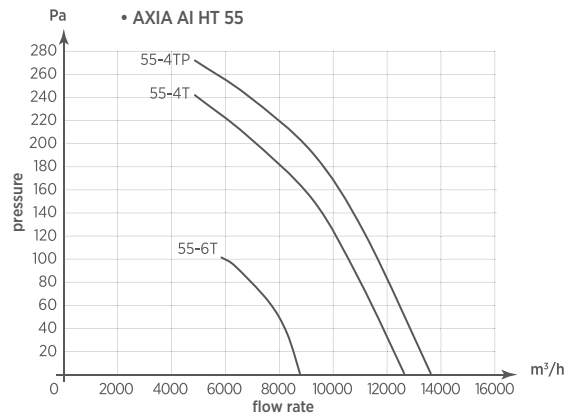
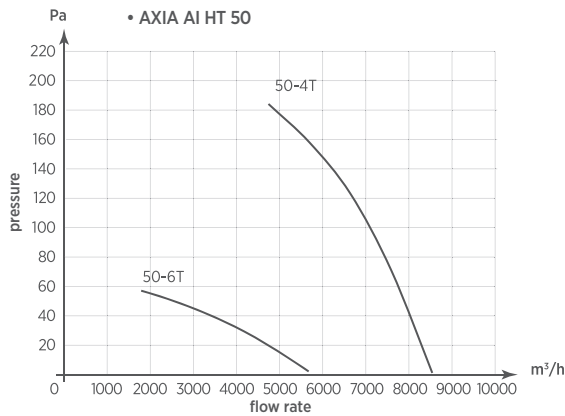
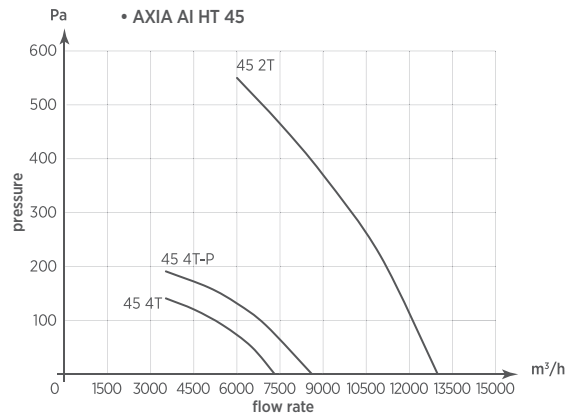
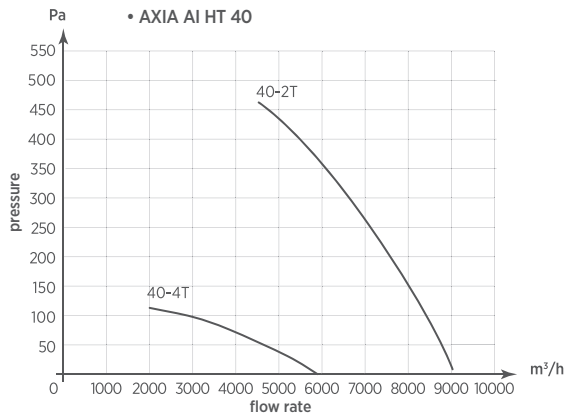

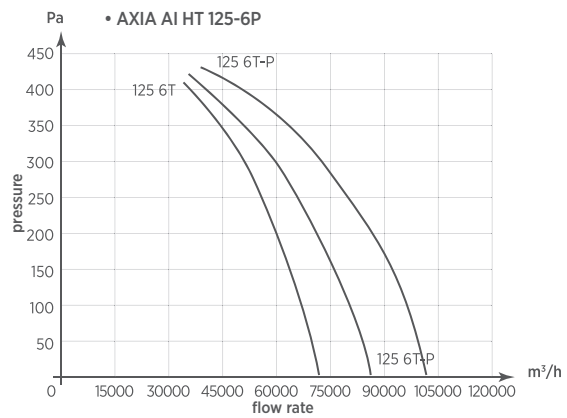
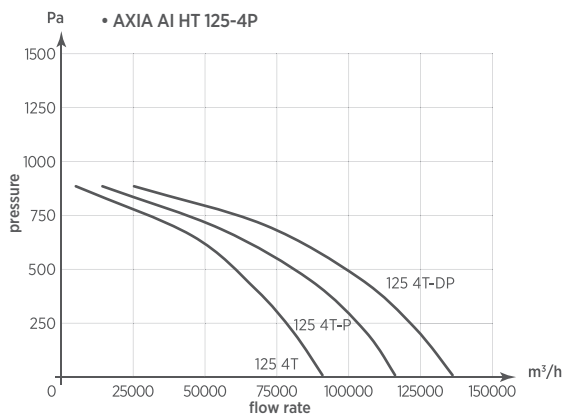
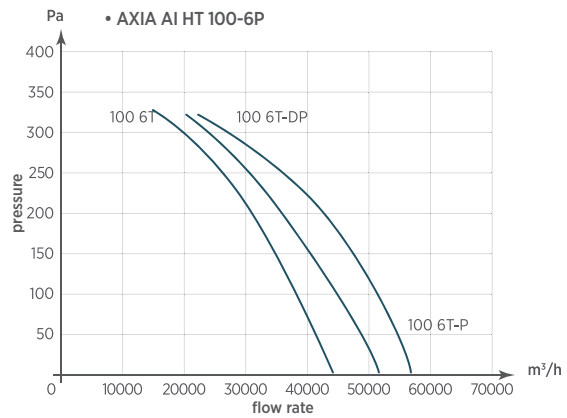
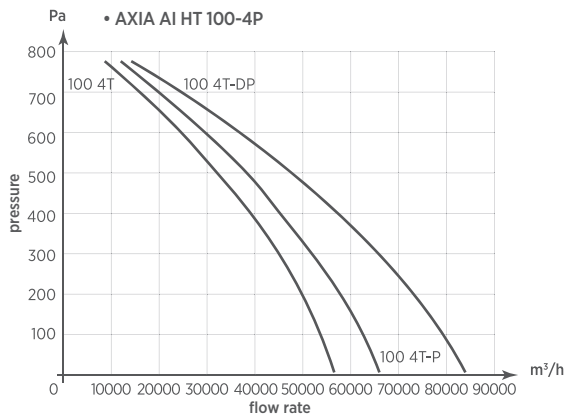
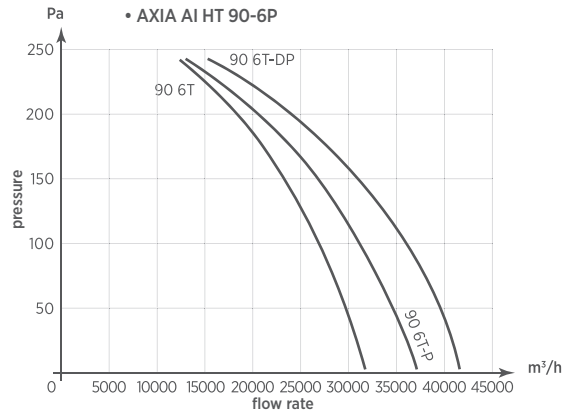
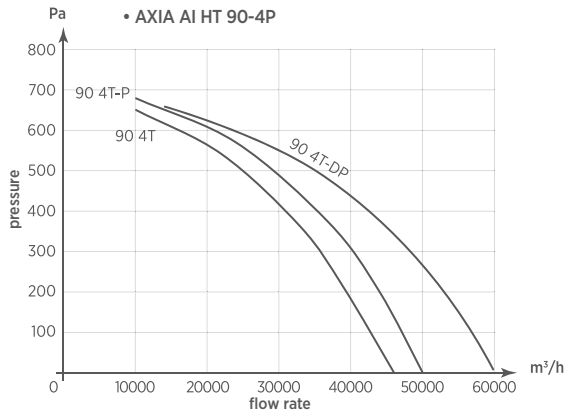
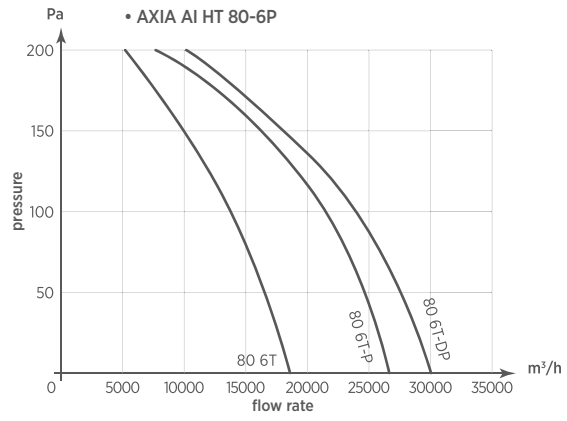
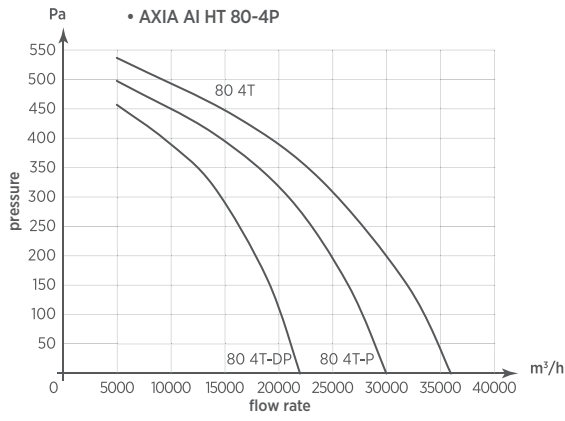

ACCESSORIES AVAILABLE ON DEMAND:

Counterflanges

Protection grilles

Floor fixing brackets

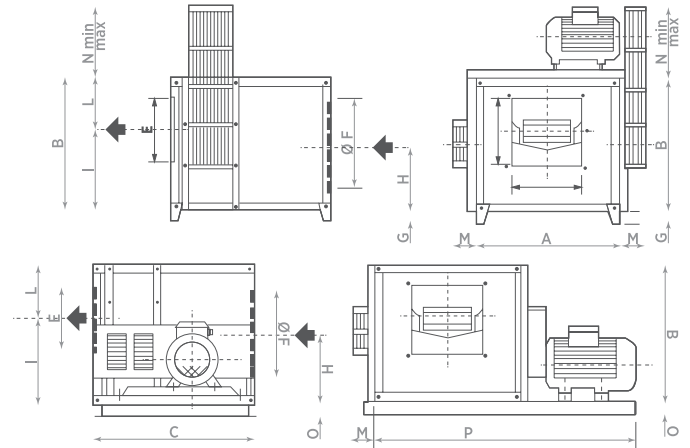

Model	A	B	C	D	E	ØF	G	H	I	L	M	N	O	P
CV-T HT 250	600	600	650	300	300	405	100	300	370	230	158	270/350	-	-
CV-T HT 300	700	680	730	350	350	500	100	340	425	255	173	340/410	-	-
CV-T HT 350	800	750	860	400	400	610	100	375	470	280	173	340/410	80	1570
CV-T HT 400	900	840	1030	450	450	650	100	420	535	305	173	360/420	100	1670
CV-T HT 450	1000	960	1200	500	500	750	100	480	630	330	173	350/420	120	1750
CV-T HT 500	1200	1020	1250	600	600	800	100	510	640	380	173	380/420	120	2150

CVT HT

SMOKE EXHAUST FANS FOR FIRE AND CAR GARAGES

Box belt driven centrifugal fans with double inlet designed to be used in fume extraction system or evacuation in case of fire according to the F400 classification.

- Suitable for continuous service at 200°C air temperature and, in case of fire (emergency) at 400°C for 2 hours
- Series composed by 6 sizes with flow rate starting from 1.500 up to 35.000 m³/h and pressure starting from 10 up to 180 mm H₂O
- Forward curved blades, double inlet
- Case in galvanised sheet
- UNEL-MEC motor IP55 protected, Class F, single speed or double speed on request
- In compliance with Standard UNI-EN 12101-3
- F400 approved by an Acknowledged Qualified Institute



POSITIONING

- Floor mounting

ENVIRONMENT APPLICATION

Suitable for:

- Fume extraction from industrial plants

- Smoke extraction systems in case of fire in residential, commercial and/or tertiary environment

TECHNICAL DATA

Model	Code	Motor	N° poles	Rev. per min. (RPM)	Voltage (Volt)	Frequency (Hz)	Flow rate (m ³ /h)	Max press. (mm H ₂ O)	Max press. (Pa)	Power (kW)	Nom. curr. (A) 230 V 400 V	IP Motor protection	Noisiness dB(A) _{1m}	Weight (Kg)
CV-T HT 250-2,2	0012601	three phase	4	1800	400	50	5700	75	736	2,20	8,1 4,7	IP55	70	85
CV-T HT 250-1,5	0012603	three phase	4	1600	400	50	5100	60	589	1,50	5,6 3,2	IP55	68	75
CV-T HT 250-1,1	0012605	three phase	4	1400	400	50	4400	45	441	1,10	4,2 2,4	IP55	65	75
CV-T HT 250-0,75	0012607	three phase	4	1200	400	50	3700	32	314	0,75	3,1 1,8	IP55	61	70
CV-T HT 250-0,37	0012609	three phase	4	1000	400	50	3100	23	226	0,37	1,8 1,1	IP55	57	68
CV-T HT 300-5,5	0012611	three phase	4	1800	400	50	9700	110	1079	5,50	18,9 10,9	IP55	76	130
CV-T HT 300-4	0012613	three phase	4	1600	400	50	8800	88	863	4,00	13,6 7,9	IP55	73	120
CV-T HT 300-3	0012615	three phase	4	1400	400	50	7700	66	647	3,00	11,0 6,4	IP55	71	110
CV-T HT 300-2,2	0012617	three phase	4	1200	400	50	6700	47	461	2,20	8,1 4,7	IP55	67	110
CV-T HT 300-1,1	0012619	three phase	4	1000	400	50	5600	33	324	1,10	4,2 2,4	IP55	63	100
CV-T HT 350-11	0012621	three phase	4	1600	400	50	13300	112	1099	11,00	36,0 20,8	IP55	78	250
CV-T HT 350-5,5	0012623	three phase	4	1400	400	50	12000	85	834	5,50	18,9 10,9	IP55	75	180
CV-T HT 350-4	0012625	three phase	4	1200	400	50	10500	63	618	4,00	13,6 7,9	IP55	72	170
CV-T HT 350-2,2	0012627	three phase	4	1000	400	50	8500	44	432	2,20	8,1 4,7	IP55	68	160
CV-T HT 350-1,1	0012629	three phase	4	800	400	50	6400	27	265	1,10	4,2 2,4	IP55	63	150
CV-T HT 400-11	0012631	three phase	4	1400	400	50	18200	118	1158	11,00	36,0 20,8	IP55	78	310
CV-T HT 400-7,5	0012633	three phase	4	1200	400	50	16000	83	814	7,50	25,4 14,7	IP55	76	300
CV-T HT 400-4	0012635	three phase	4	1000	400	50	13000	58	569	4,00	13,6 7,9	IP55	72	220
CV-T HT 400-2,2	0012637	three phase	4	800	400	50	10200	37	363	2,20	8,1 4,7	IP55	67	210
CV-T HT 450-22	0012639	three phase	4	1400	400	50	25500	150	1472	22,00	69,7 40,3	IP55	78	520
CV-T HT 450-15	0012641	three phase	4	1200	400	50	22000	112	1099	15,00	48,1 27,8	IP55	76	440
CV-T HT 450-7,5	0012643	three phase	4	1000	400	50	18000	78	765	7,50	25,4 14,7	IP55	72	360

Model	Code	Motor	N° poles	Rev. per min. (RPM)	Voltage (Volt)	Frequency (Hz)	Flow rate (m³/h)	Max press. (mm H ₂ O)	Max press. (Pa)	Power (kW)	Nom. curr. (A) 230 V	Nom. curr. (A) 400 V	IP Motor protection	Noisiness dB(A) _{3m}	Weight (Kg)
CV-T HT 450-4	0012645	Trifase	4	800	400	50	14800	50	491	4,00	13,6	7,9	IP55	67	270
CV-T HT 450-1,5	0012647	Trifase	4	600	400	50	11100	28	275	1,50	5,6	3,2	IP55	64	250
CV-T HT 500-30	0012649	Trifase	4	1400	400	50	35000	180	1766	30,00	94,5	54,6	IP55	86	610
CV-T HT 500-22	0012651	Trifase	4	1200	400	50	30000	135	1324	22,00	69,7	40,3	IP55	82	580
CV-T HT 500-15	0012653	Trifase	4	1000	400	50	25000	90	883	15,00	48,1	27,8	IP55	78	500
CV-T HT 500-7,5	0012655	Trifase	4	800	400	50	20000	60	589	7,50	25,4	14,7	IP55	74	420
CV-T HT 500-3	0012657	Trifase	4	600	400	50	15100	32	314	3,00	11,0	6,4	IP55	68	310

FLOW CHARTS

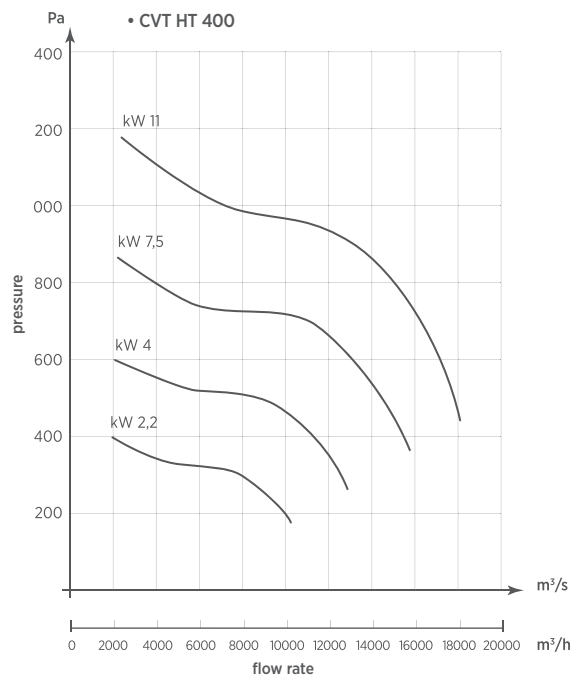
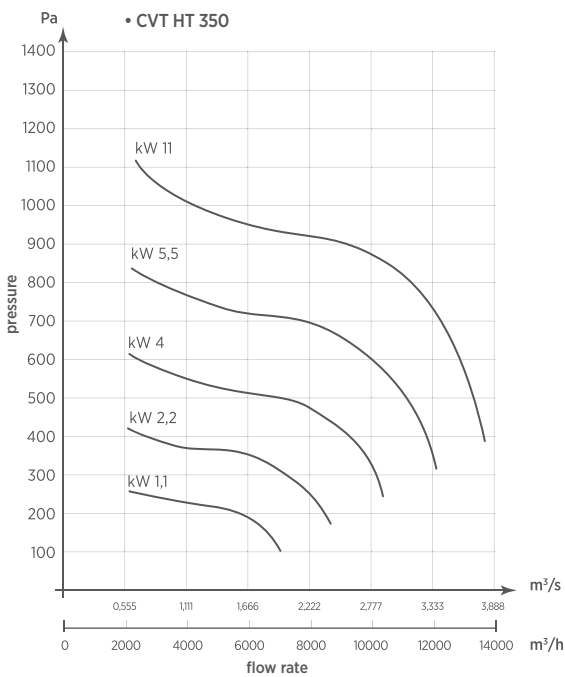
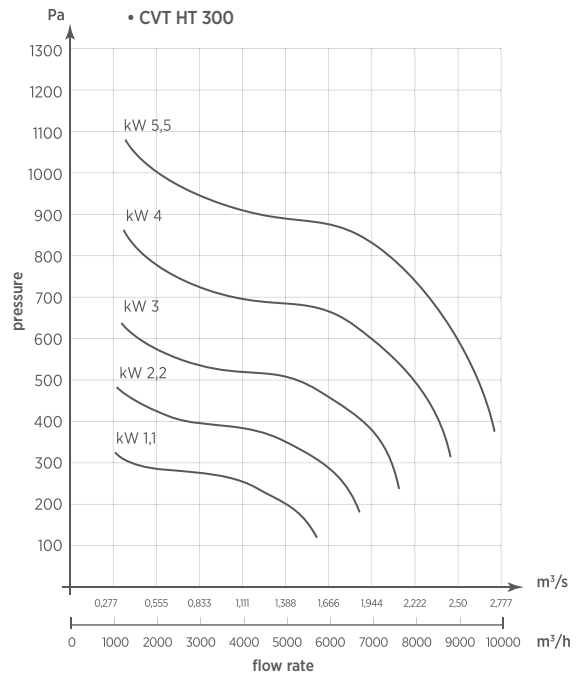
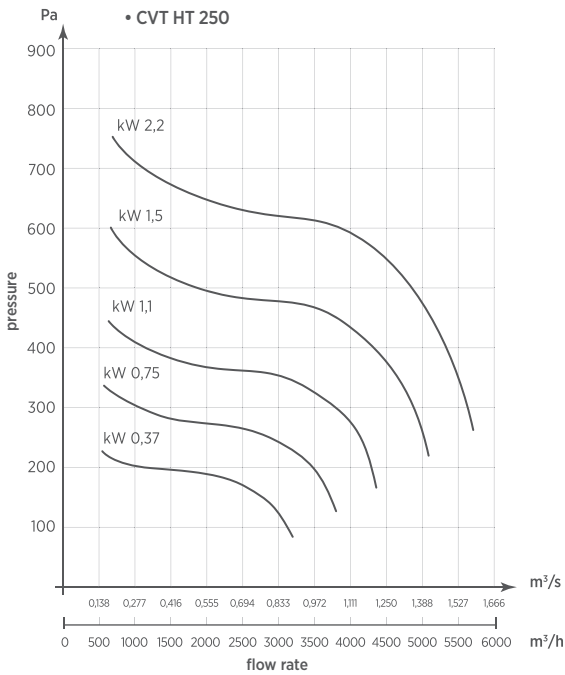

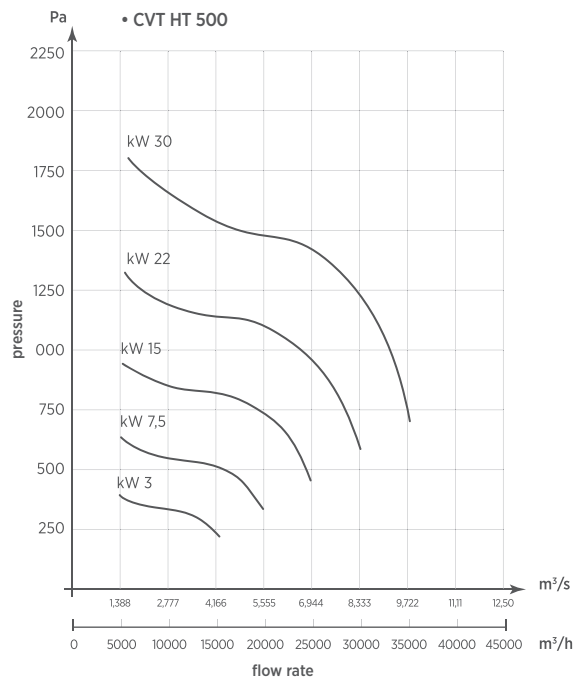
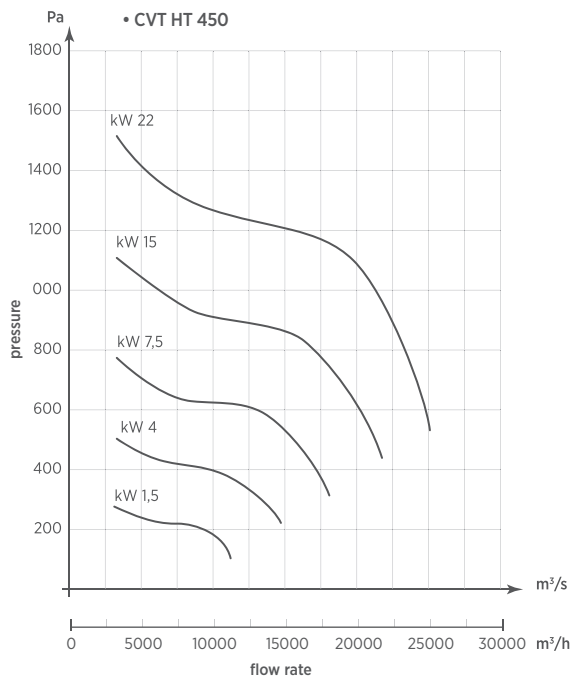

ACCESSORIES AVAILABLE ON DEMAND

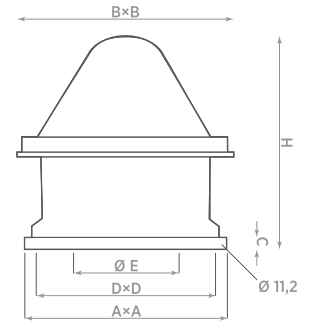

Model	A×A	B×B	C	D×D	ØE	H
TXP 6	400	470	40	350	250	520
TXP 7	560	595	40	460	300	650
TXP 8	560	595	40	460	350	650
TXP 10	710	800	40	610	400	700
TXP 12	900	1000	40	800	500	880
TXP 14	900	1000	45	800	550	910
TXP 15	900	1000	45	800	600	940
TXP 18	900	1000	45	800	600	960

TXP 400°C 2h

SMOKE EXHAUST FANS FOR FIRE AND CAR GARAGES

Centrifugal roof fans to extract air 400°C 2h with horizontal outlet.

- Centrifugal roof fans to extract air or fumes directly outside or through ducts;
- Medium-high flow rates to overcome pressure losses due to duct resistance;
- Suitable to be installed where is required to extract air or fumes in case of fire such as: industries, sports facilities, supermarket and shopping centres, cinemas, offices;
- Ball bearing class F insulation motor IP55 protected;
- Max temperature of extracted air in continuous operation: 60°C;
- Max temperature of extracted air in case of fire: 400°C for 2 hours;
- Easy installation;
- Zinc plated steel frame, protection cover in ABS material;
- Safety protection outside grille;
- Self cleaning backward centrifugal impeller;
- In accordance with European Standard: EN 12101-3.



POSITIONING

- Roof mounting

ENVIRONMENTS APPLICATION

Suitable for evacuation systems in case of fire in:

- Shopping centers
- underground car parkings
- Hospitals
- Schools
- theatres
- museums
- buildings and skyscrapers

TECHNICAL DATA

Model	Code	Motor	N° poles	Rev. per min. (RPM)	Voltage (Volt)	Frequency (Hz)	Flow rate (m³/h)	Max press. (mm H₂O)	Max press. (Pa)	Power (W)	Nom. curr. (A)		IP Motor protection	Noisiness dB(A) _{2m}	Weight (Kg)
											230 V	400 V			
TXP 6M 4P 400 2H	0074240	single phase	4	1400	230	50-60	1800	30	294	180	1,05	-	IP55	66	20
TXP 7M 4P 400 2H	0074340	single phase	4	1400	230	50-60	3100	40	392	250	1,4	-	IP55	69	28
TXP 8M 4P 400 2H	0074440	single phas	4	1400	230	50-60	4200	45	441	370	1,9	-	IP55	70	34
TXP 10M 4P 400 2H	0074540	single phas	4	1400	230	50-60	5700	56	549	750	3,4	-	IP55	75	45
TXP 6T 4P 400 2H	0074740	three phase	4	1400	230/400	50-60	1800	30	294	180	1,05	0,6	IP55	66	20
TXP 7T 4P 400 2H	0074840	three phase	4	1400	230/400	50-60	3100	40	392	250	1,42	0,82	IP55	69	28
TXP 8T 4P 400 2H	0074940	three phase	4	1400	230/400	50-60	4200	45	441	370	1,9	1,1	IP55	70	34
TXP 10T 4P 400 2H	0075040	three phase	4	1400	230/400	50-60	5700	56	549	750	3,4	1,8	IP55	75	45
TXP 12T 6P 400 2H	0075140	three phase	6	900	230/400	50-60	7100	39	382	750	3,81	2,2	IP55	71	63
TXP 14T 6P 400 2H	0075240	three phase	6	900	230/400	50-60	10800	48	471	1100	5,37	3,1	IP55	75	85
TXP 15T 6P 400 2H	0075440	three phase	6	900	230/400	50-60	14200	57	559	2200	9,35	5,4	IP55	80	105
TXP 18T 6P 400 2H	0075540	three phase	6	900	230/400	50-60	18800	65	637	3000	11,95	6,9	IP55	84	120

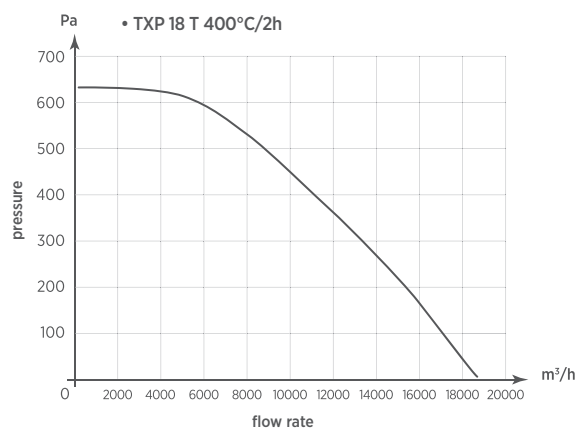
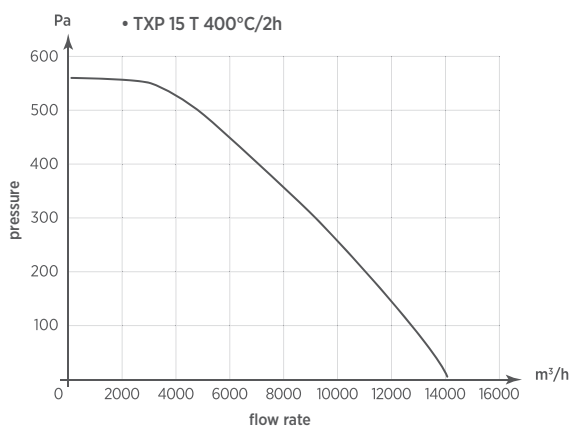
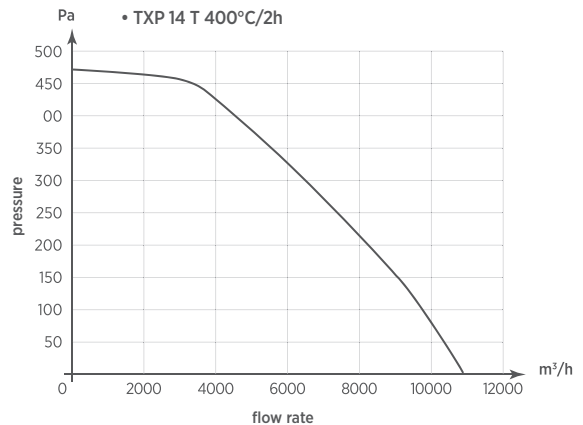
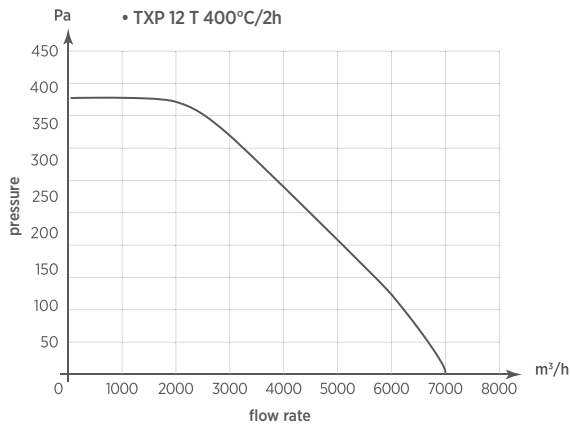
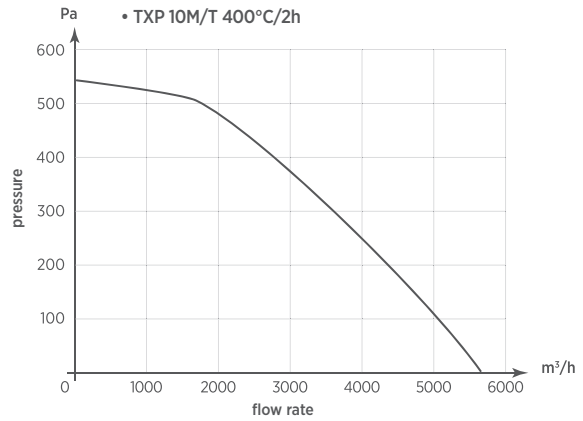
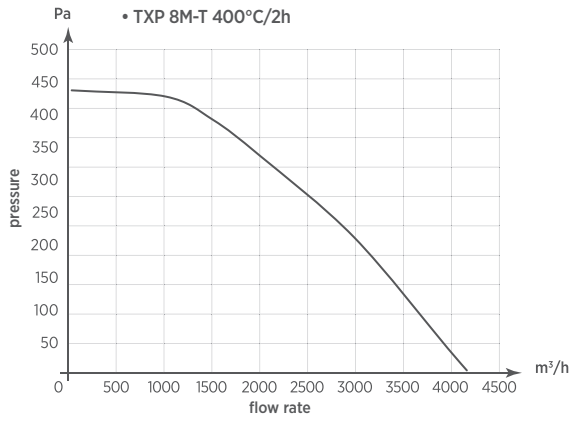
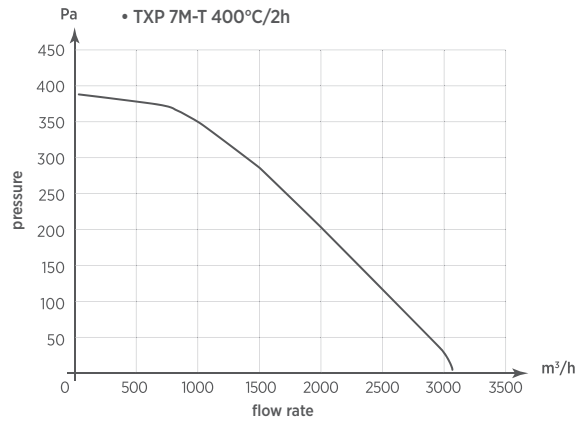
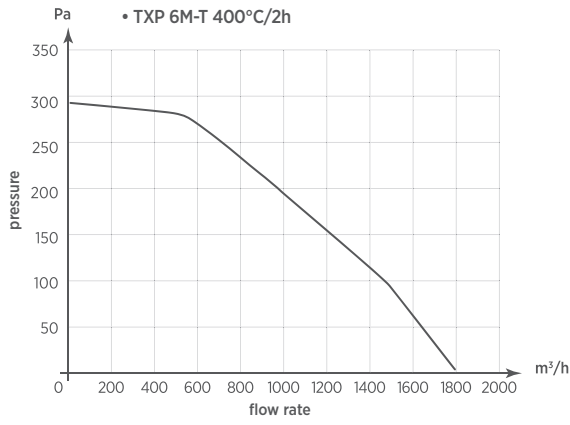

ACCESSORIES:
SEE PAGE 85

Frame
base

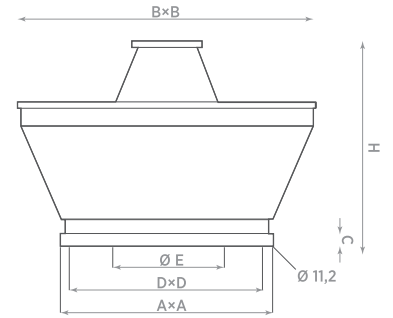

Model	A x A	B x B	C	D x D	Ø E	H
TXV 6	400	595	40	350	250	500
TXV 7	560	800	40	460	300	640
TXV 8	560	800	40	460	350	640
TXV 10	710	1000	40	610	400	700
TXV 12	900	1260	40	800	500	780
TXV 14	900	1260	45	800	550	820
TXV 15	900	1260	45	800	600	870

TXV 400°C 2h

SMOKE EXHAUST FANS FOR FIRE AND CAR GARAGES

TCentrifugal roof fans to extract air 400°C 2h with vertical outlet.

- Centrifugal roof fans to extract air or fumes directly outside or through ducts;
- The vertical extracted air avoids to stain the lateral walls or components;
- Medium-high flow rates to overcome pressure losses due to duct resistance;
- Suitable to be installed where is required to extract air or fumes in case of fire such: industries, sports facilities, supermarket and shopping centres, cinemas, offices;
- Ball bearing class F insulation motor IP55 protected;

- Max temperature of extracted air in continuous operation: 60°C;
- Max temperature of extracted air in case of fire: 400°C for 2 hours;
- Easy installation;
- Zinc plated steel frame, protection cover in ABS material;
- Safety protection outside grille;
- Self cleaning backward centrifugal impeller;
- In accordance with European Standard: EN 12101-3.



POSITIONING

- Roof mounting

ENVIRONMENT APPLICATION

Suitable for evacuation systems in case of fire in:

- Shopping centers
- underground car parkings
- Hospitals
- Schools
- theatres
- museums
- buildings and skyscrapers

TECHNICAL DATA

Model	Code	Motor	N° poles	Rev. per min. (RPM)	Voltage (Volt)	Frequency (Hz)	Flow rate (m³/h)	Max press. (mm H₂O)	Max press. (Pa)	Power (W)	Nom. curr. (A) 230 V 400 V	IP Motor protection	Noisiness dB(A) _{2m}	Weight (Kg)
TXV 6M 4P 400 2H	0074260	single phase	4	1400	230	50-60	1800	30	294	180	1,05 -	IP55	66	25
TXV 7M 4P 400 2H	0074360	single phase	4	1400	230	50-60	3100	40	392	250	1,4 -	IP55	69	33
TXV 8M 4P 400 2H	0074460	single phase	4	1400	230	50-60	4200	45	441	370	1,9 -	IP55	70	4
TXV 10M 4P 400 2H	0074560	single phase	4	1400	230	50-60	5700	56	549	750	3,4 -	IP55	75	52
TXV 6T 4P 400 2H	0074760	single phase	4	1400	230/400	50-60	1800	30	294	180	1,05 0,6	IP55	66	25
TXV 7T 4P 400 2H	0074860	three phase	4	1400	230/400	50-60	3100	40	392	250	1,42 0,82	IP55	69	33
TXV 8T 4P 400 2H	0074960	three phase	4	1400	230/400	50-60	4200	45	441	370	1,9 1,1	IP55	70	40
TXV 10T 4P 400 2H	0075060	three phase	4	1400	230/400	50-60	5700	56	549	750	3,4 1,8	IP55	75	52
TXV 12T 6P 400 2H	0075160	three phase	6	900	230/400	50-60	7100	39	382	750	3,81 2,2	IP55	71	73
TXV 14T 6P 400 2H	0075260	three phase	6	900	230/400	50-60	10800	48	471	1100	5,37 3,1	IP55	75	95
TXV 15T 6P 400 2H	0075460	three phase	6	900	230/400	50-60	14200	57	559	2200	9,35 5,4	IP55	80	116
TXV 18T 6P 400 2H	0075560	three phase	6	900	230/400	50-60	18800	65	637	3000	11,95 6,9	IP55	84	132

FLOW CHARTS

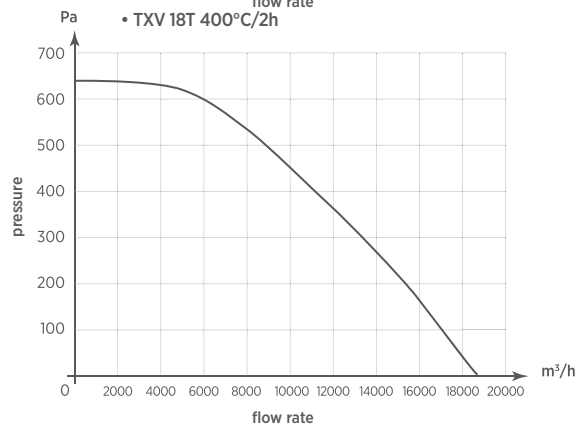
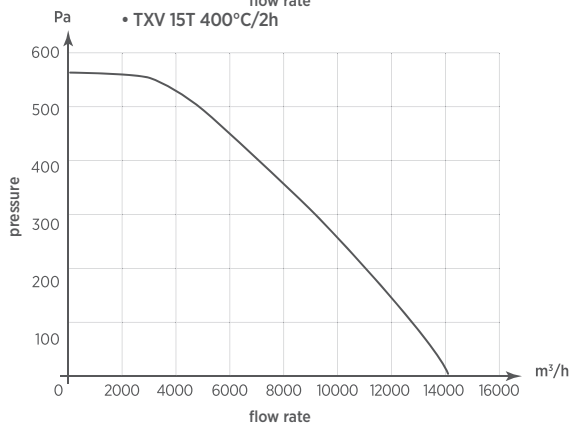
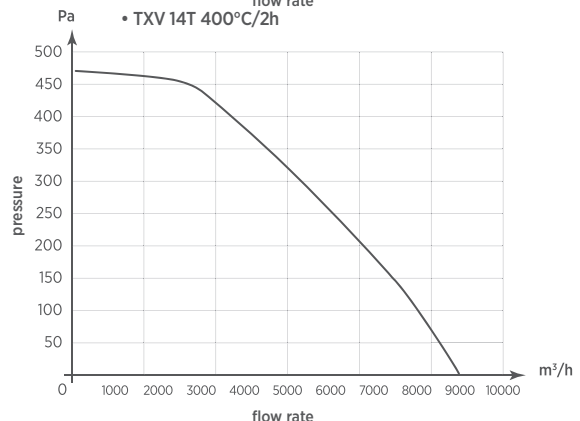
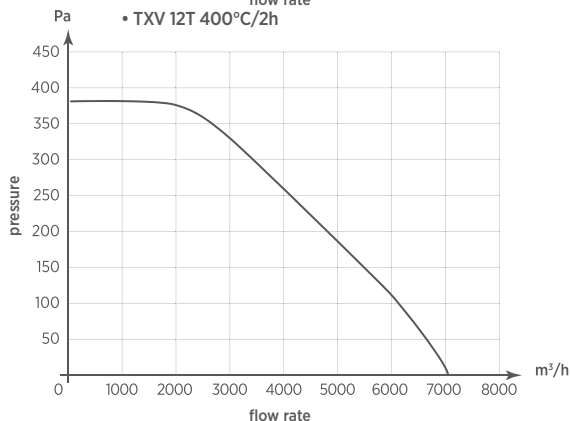
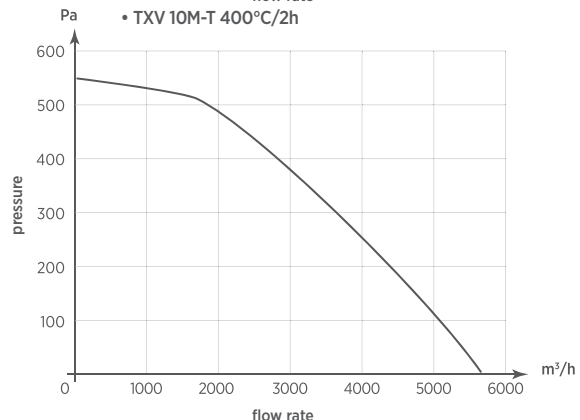
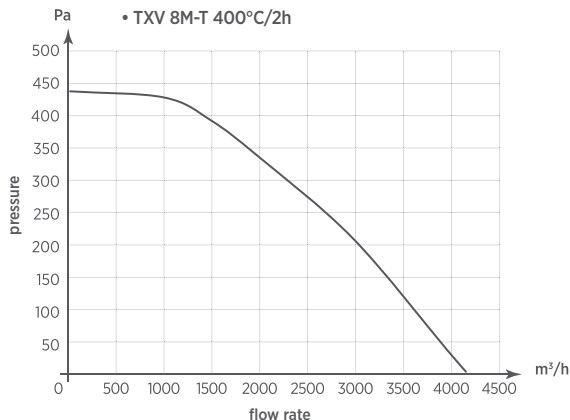
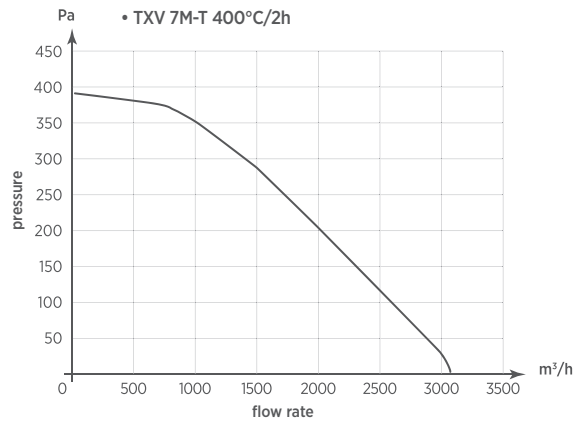
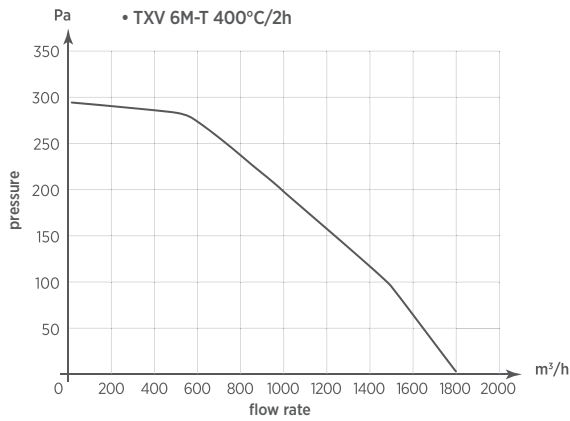

ACCESSORIES:
SEE PAGE 85

Frame
base

ACCESSORIES

ACCESSORIES: IP55 INDUSTRIAL CONTROLLERS

- Speed controllers for industrial fans;
- Body made of plastic material;
- Equipped with an operating indication light;
- IP55 protected;
- Equipped with cable gland;
- Suitable for wall installation.

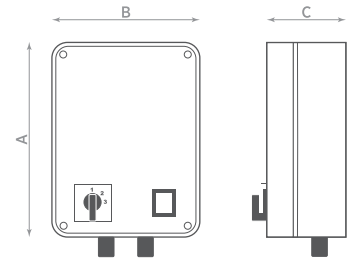

CE IP55  (RGM2 - RGM 10)

Description	Code	I max	Power	A	B	C
RGM 2	0030000	1,6 A	350 VA	108	108	100
RGM 4	0030200	4 A	900 VA	250	190	140
RGT 1	0030300	1 A	700 VA	250	190	140
RGT 2	0030400	2 A	1300 VA	320	240	150
RG 10	0031300	-	-	105	125	52
RGM 10 (0-10V)	0030600	-	-	108	108	100

Series	Model	RGM 2	RGM 4	RGT 1	RGT 2	RGM 10
TURBO - TURBOPLAST AC	All models	•				
	150 2M	•				
	150 2T			•		
CB	210 2M - 220 2M	•				
	230 2M - 240 2M		•			
	210 2T - 220 2T			•		
CS	230 2T - 240 2T				•	
	310 4M	•				
	320 4M		•			
CAI	310 4T			•		
	320 4T - 330 4T - 340 4T				•	
	510 2M - 520 2M	•				
CAA	530 2M - 540 2M		•			
	510 2T - 520 2T			•		
	530 2T - 540 2T				•	
TXC TURBOCAMINO TXP - TXV	610 2T - 620 4T			•		
	630 4T				•	
	All models	•				
AXIA DES	3M - 6M	•				
	7M - 8M - 10M		•			
	3T - 6T - 7T			•		
AXIA AI	8T - 10 T				•	
	450 6M	•				
	600 6M - 710 6M		•			
AXIA AI ECO	25 2M - 25 4M - 30 4M - 35 4M - 40 4M	•				
	30 2M - 45 4M		•			
	25 2T - 30 2T - 25 4T - 30 4T - 35 4T - 40 4T			•		
AXIA LD	45 4T - 50 4T - 60 6T				•	
	25M - 30M - 35M - 40M - 45M - 50M - 60M					•
	20 4M - 25 4M - 30 4M - 35 4M	•				
AXIA MD	25 4M - 30 4M - 35 4M - 40 4M - 50 6M - 60 6M	•				
	50 4M - 60 4M		•			
	25 4T - 30 4T - 35 4T - 40 4T - 50 4T - 50 6T - 60 4T - 60 6T			•		
AXIA HD	25 4M - 30 4M - 35 4M - 40 4M - 50 6M	•				
	50 4M - 60 4M - 60 6M		•			
	25 4T - 30 4T - 35 4T - 40 4T - 50 6T			•		
AXIA TT	50 4T - 60 4T - 60 6T				•	
	20 2M - 20 4M - 25 4M - 30 4M - 35 4M - 40 4M	•				
	25 4T - 30 4T - 35 4T - 40 4T			•		
AXIA TT ECO	50 4T - 60 6T				•	
	25 M - 30 M - 35 M - 40 M - 50 M - 60 M					•

ACCESSORIES

CONTROLLERS:

RGE: Electronic controller with stepless speed. To control motor ON/OFF; variable speed and airflow reversibility (if available on the product).
 RG 10: Electronic controller to regulate the speed of products equipped with EC motors 0-10Voltage at speed controlled. They can be recessed through a dedicated accessory Code 0090500 (on request).

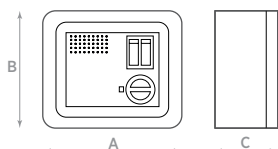

Model	Code	Suitable for series	A	B	C
RGE	0031700	Single phase fans up to 300 W	125	105	52
RG 10 (0-10 V)	0031300	AXIA TT ECO	125	105	52
Recessed wall kit controller RG 10 (0-10 V)	0090500	RGE - RG 10	125	105	52

DUCT CLAMP

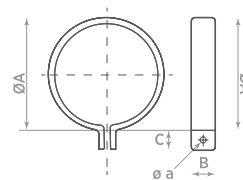

Descrizione	Codice	Suitable for	ØA	B	C	Øa
Duct clamp 100	0061400	IL R - Turbo - Turboplast 100	105	40	20	7
Duct clamp 125	0061500	IL R - II C - Turbo - Turboplast 125	130	40	20	7
Duct clamp 150/160	0062000	IL R - IL C - AC - Turbo - Turboplast150/160	165	40	20	7
Duct clamp 200	0061700	IL R - IL C - Turbo 200	205	40	20	7
Duct clamp 250	0061800	IL R - IL C - Turbo 250	255	40	20	7
Duct clamp 315	0061900	IL R - IL C - Turbo 315	320	40	20	7

PROTECTION GRILLE

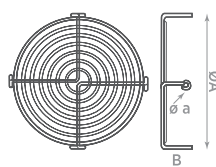
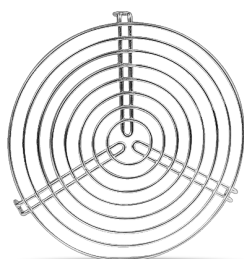

Description	Code	Suitable for	ØA	B	Øa
Protection grille 100	0060800	Turbo 100 - IL R 100	100	20	4,5
Protection grille 125	0060900	Turbo 125 - IL R 125 - IL C 125	125	20	4,5
Protection grille 150	0061000	AC - Turbo 150 - IL R 150 - IL C 150	150	20	4,5
Protection grille 160	0062900	Turbo 160 - IL C 160	160	20	4,5
Protection grille 200	0061100	Turbo 200 - IL R 200 - IL C 200	200	20	4,5
Protection grille 250	0061200	Turbo 250 - IL R 250 - IL C 250	250	20	4,5
Protection grille 315	0061300	Turbo 315 - IL R 315 - IL C 315	315	20	4,5

BACKDRAUGHT SHUTTER

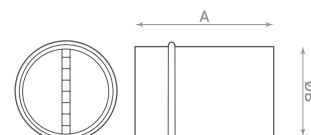

Description	Code	Suitable for	A	ØB
Backdraught shutter 100	0062200	Turbo 100 - IL R 100	77	94
Backdraught shutter 125	0062300	Turbo 125 - IL R 125 - IL C 125	90	119
Backdraught shutter 150/160	0062100	AC - Turbo 150/160 - IL R 150 - IL C 150/160	100	156
Backdraught shutter 200	0062500	Turbo 200 - IL R 200 - IL C 200	127	194
Backdraught shutter 250	0062600	Turbo 250 - IL R 250 - IL C 250	152	244
Backdraught shutter 315	0062700	Turbo 315 - IL R 315 - IL C 315	185	309

PROTECTION GRILLE

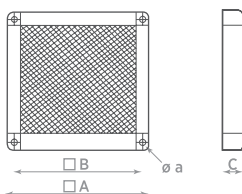

Description	Code	Suitable for	A	B	C	Øa
Protection grille 200	0059400	AXIA LD-TT 20	310	268	52	9
Protection grille 250	0059500	AXIA LD-MD-HD-TT-TT ECO 25	367	325	52	9
Protection grille 300	0059600	AXIA LD-MD-HD-TT-TT ECO 30	424	382	52	9
Protection grille 350	0059700	AXIA LD-MD-HD-TT-TT ECO 35	481	439	52	9
Protection grille 400	0059800	AXIA MD-HD-TT-TT ECO 40	538	496	52	9
Protection grille 500	0059900	AXIA MD-HD-TT-TT ECO 50	652	610	52	9
Protection grille 600	0060000	AXIA MD-HD-TT-TT ECO 60	823	781	52	9

GRAVITY SHUTTER

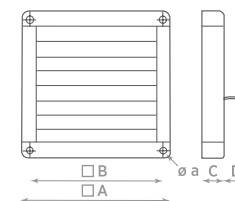

Description	Code	Suitable for	A	B	C	D	Øa
Gravity shutter 200	0060100	AXIA LD-TT 20	310	268	52	54	9
Gravity shutter 250	0060200	AXIA LD-MD-HD-TT-TT ECO 25	367	325	52	54	9
Gravity shutter 300	0060300	AXIA LD-MD-HD-TT-TT ECO 30	424	382	52	54	9
Gravity shutter 350	0060400	AXIA LD-MD-HD-TT-TT ECO 35	481	439	52	54	9
Gravity shutter 400	0060500	AXIA MD-HD-TT-TT ECO 40	538	496	52	54	9
Gravity shutter 500	0060600	AXIA MD-HD-TT-TT ECO 50	652	610	52	54	9
Gravity shutter 600	0060700	AXIA MD-HD-TT-TT ECO 60	823	781	52	54	9

SPACER

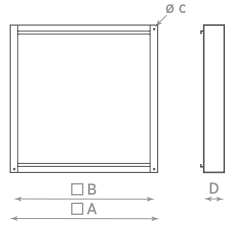
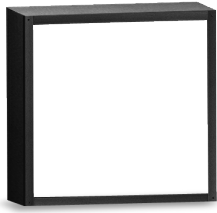

Description	Code	Suitable for	A	B	C	D
Spacer D 200	0065100	AXIA LD-TT 20	310	268	9	63
Spacer D 250	0065200	AXIA LD-MD-HD-TT-TT ECO 25	367	325	9	73
Spacer D 300	0065300	AXIA LD-MD-HD-TT-TT ECO 30	424	382	9	75,5
Spacer D 350	0065400	AXIA LD-MD-HD-TT-TT ECO 35	481	439	9	101,5
Spacer D 400	0065500	AXIA MD-HD-TT-TT ECO 40	538	496	9	116,5
Spacer D 500	0065600	AXIA MD-HD-TT-TT ECO 50	652	610	9	119,5
Spacer D 600	0065700	AXIA MD-HD-TT-TT ECO 60	823	781	9	130,5

SAFETY PROTECTION GRILLE

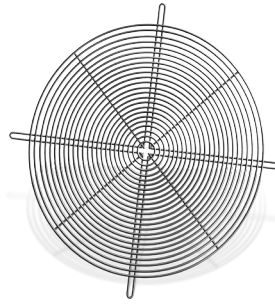

Description	Code	Suitable for
Safety protection grille AI R 25	0072982	AXIA AI - AI ECO 25 - HP
Safety protection grille AI R 30	0072983	AXIA AI - AI ECO 30 - HP
Safety protection grille AI R 35	0072984	AXIA AI - AI ECO 35 - HP
Safety protection grille AI R 40	0072985	AXIA AI - AI ECO 40 - HP
Safety protection grille AI R 45	0072986	AXIA AI - AI ECO 45 - HP
Safety protection grille AI R 50	0072987	AXIA AI - AI ECO 50 - HP
Safety protection grille AI R 60	0072949	AXIA AI - AI ECO 60 - HP

CONNECTION FLANGE



Description	Code	Suitable for series
Connection flange AI F 25	0072994	AXIA AI - AI ECO 25
Connection flange AI F 30	0072995	AXIA AI - AI ECO - AI HP 30
Connection flange AI F 35	0072996	AXIA AI - AI ECO - AI HP 35
Connection flange AI F 40	0072997	AXIA AI - AI ECO - AI HP 40
Connection flange AI F 45	0072998	AXIA AI - AI ECO - AI HP 45
Connection flange AI F 50	0072999	AXIA AI - AI ECO - AI HP 50
Connection flange AI F 60	0072948	AXIA AI - AI ECO - AI HP 60

EXTENSION RING



Description	Code	Suitable for series
Extension ring AI pro 25	0072903	AXIA AI - AI ECO 25
Extension ring AI pro 30	0072908	AXIA AI - AI ECO - AI HP 30
Extension ring AI pro 35	0072913	AXIA AI - AI ECO - AI HP 35
Extension ring AI pro 40	0072918	AXIA AI - AI ECO - AI HP 40
Extension ring AI pro 45	0072923	AXIA AI - AI ECO - AI HP 45
Extension ring AI pro 50	0072928	AXIA AI - AI ECO - AI HP 50
Extension ring AI pro 60	0072947	AXIA AI - AI ECO - AI HP 60

FLEXIBLE CONNECTION



Descrizione	Code	Suitable for series
Flexible connection AI F 25	0072994	AXIA AI - AI ECO 25
Flexible connection AI F 30	0072995	AXIA AI - AI ECO - AI HP 30
Flexible connection AI F 35	0072996	AXIA AI - AI ECO - AI HP 35
Flexible connection AI F 40	0072997	AXIA AI - AI ECO - AI HP 40
Flexible connection AI F 45	0072998	AXIA AI - AI ECO - AI HP 45
Flexible connection AI F 50	0072999	AXIA AI - AI ECO - AI HP 50
Flexible connection AI F 60	0072948	AXIA AI - AI ECO - AI HP 60

SUPPORT

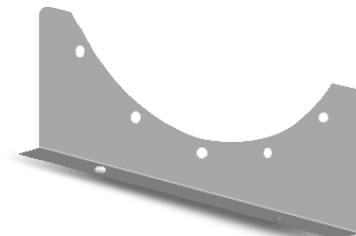

Description	Code	Suitable for series
Supporto AI SP 25	0072988	AXIA AI - AI ECO 25
Supporto AI SP 30	0072989	AXIA AI - AI ECO - AI HP 30
Supporto AI SP 35	0072989	AXIA AI - AI ECO - AI HP 35
Supporto AI SP 40	0072991	AXIA AI - AI ECO - AI HP 40
Supporto AI SP 45	0072992	AXIA AI - AI ECO - AI HP 45
Supporto AI SP 50	0072993	AXIA AI - AI ECO - AI HP 50
Supporto AI SP 60	0072943	AXIA AI - AI ECO - AI HP 60

CONNECTION SQUARE TO ROUND

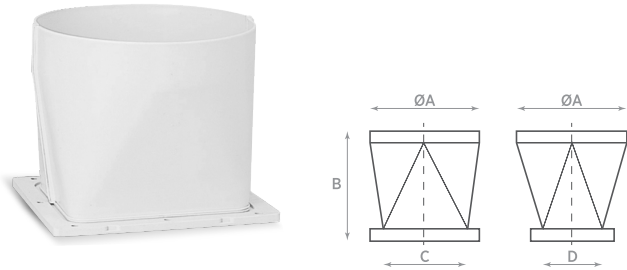

Description	Code	Suitable for	ØA	B	C	D
Outlet for CAA 610	0063000	CAA 610	125	105	90	90
Outlet for CAA 620	0063100	CAA 620	200	160	165	135
Outlet for CAA 630 Ø 315	0063200	CAA 630	250	160	205	165
Outlet for CAA 640 Ø 315	0063400	CAA 640	315	200	245	205
Outlet for CAA 650 Ø 355	0063500	CAA 650	315	205	290	235
Outlet for CAA 650	0063600	CAA 650	355	205	290	235

FRAME BASE

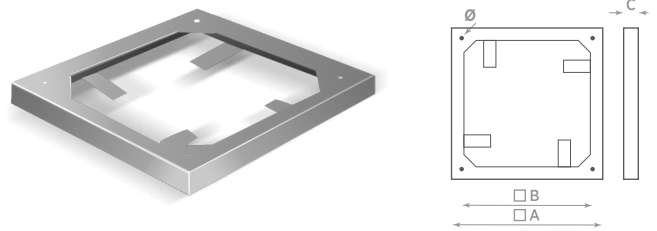

Description	Code	Suitable for series	A	B	C	Kg
Frame base TXP - TXV 3/6	0080600	TXP-TXV / TXP-TXV 400°C/2h	390	350	40	0,8
Frame base TXP - TXV 7/8	0080700	TXP-TXV / TXP-TXV 400°C/2h	550	460	40	1,6
Frame base TXP - TXV 10	0080800	TXP-TXV / TXP-TXV 400°C/2h	700	610	40	2
Frame base TXP - TXV 12/14/15/18	0080900	TXP-TXV / TXP-TXV 400°C/2h	890	800	40	3,2

REDUCER

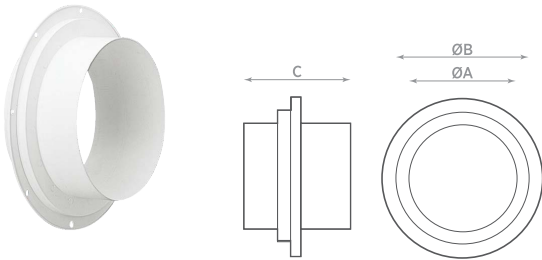

Description	Code	Suitable for	ØA	B	C
Reducer Ø315/250 - CAA 640	0066800	CAA 640	250	315	147

GRAVITY SHUTTER

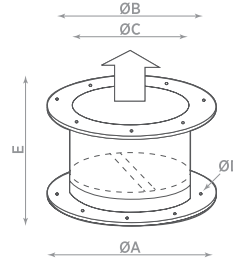

Description	Code	Suitable for series	ØA	ØB	ØC	ØD	E	Kg
G. S. TXP - TXV 3	0078600	TXP-TXV / TXP-TXV 400°/2h	259	235	200	3xM8	150	1,1
G. S. TXP - TXV 6	0078700	TXP-TXV / TXP-TXV 400°/2h	309	283	250	3xM8	210	1,8
G. S. TXP - TXV 7	0078800	TXP-TXV / TXP-TXV 400°/2h	359	330	300	3xM8	210	2,6
G. S. TXP - TXV 8	0078900	TXP-TXV / TXP-TXV 400°/2h	409	381	350	4xM8	230	3,4
G. S. TXP - TXV 10	0079000	TXP-TXV / TXP-TXV 400°/2h	460	431	400	4xM8	250	4,2
G. S. TXP - TXV 12	0079100	TXP-TXV / TXP-TXV 400°/2h	560	533	500	5xM8	300	5,8
G. S. TXP - TXV 14	0079200	TXP-TXV / TXP-TXV 400°/2h	620	585	550	6xM8	320	6,6
G. S. TXP - TXV 15/18	0079300	TXP-TXV / TXP-TXV 400°/2h	661	636	600	7xM8	320	7,3

ANGLED OUTLET

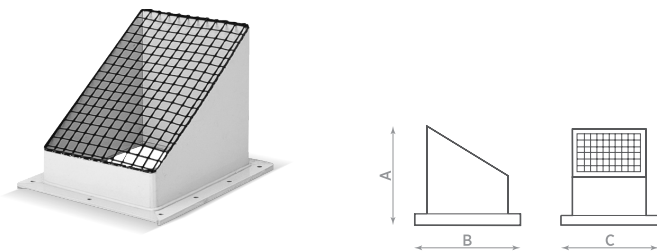

Description	Code	Suitable for	A	B	C
Angled outlet	0067700	CAA 610	90	90	90
Angled outlet	0067800	CAA 620	160	165	135
Angled outlet	0067900	CAA 630	208	205	165
Angled outlet	0068000	CAA 640	60	245	205
Angled outlet	0068100	CAA 650	260	290	235

SHUTTER

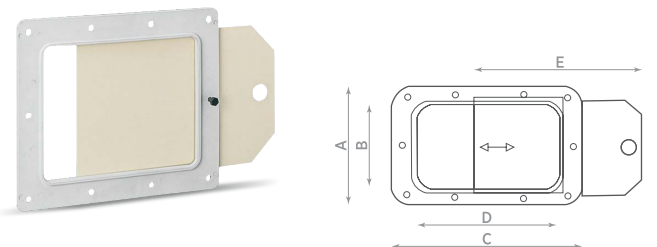

Descrizione	Code	Suitable for	A	B	C	D	E
Shutter	0066900	CAA 630	230	165	265	205	274
Shutter	0067000	CAA 640	263	205	303	245	332
Shutter	0067100	CAA 650	305	235	355	290	372

GRAVITY SHUTTER

Description	Code	Suitable for series
Gravity shutter	0055110	TXA 40
Gravity shutter	0055120	TXA 50
Gravity shutter	0055130	TXA 63
Gravity shutter	0055140	TXA 71
Gravity shutter	0055150	TXA 80
Gravity shutter	0055160	TXA 100

IMPELLER HOUSING ROTATION

OUTPUT DIRECTION AND HOUSING ROTATION VIEWED FROM MOTOR SIDE

AMCA STANDARD 99 - 2406 -83

COUNTER CLOCKWISE ROTATION CCW (LG)

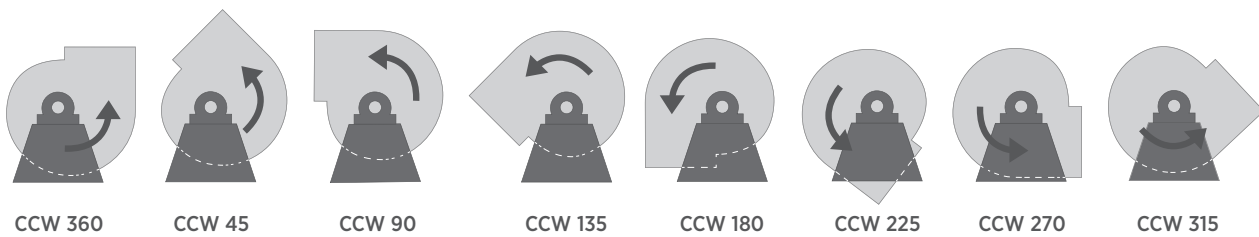

CLOCKWISE ROTATION CW (RD)

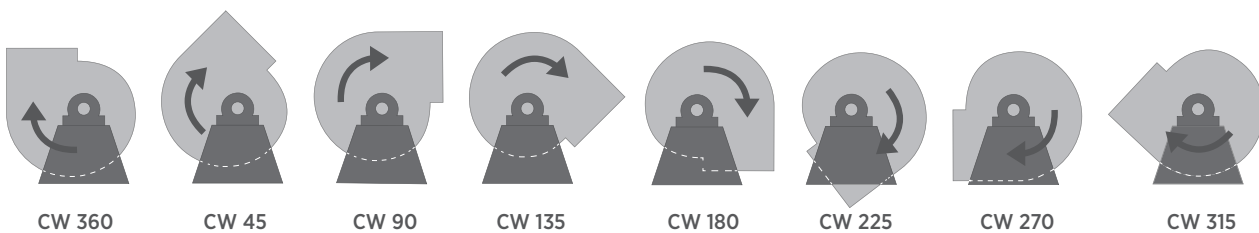

 All products included in this catalogue meet the essential requirements of EU directives.

In order to improve its offer, O.ERRE reserves the right to change sizes, features and design, or delete entire references of its products without notice.

